



## INSTRUCTION MANUAL

VHF TRANSCEIVER

**IC-F3161DT**  
**IC-F3161DS**

UHF TRANSCEIVER

**IC-F4161DT**  
**IC-F4161DS**

This device complies with Part 15 of the FCC Rules. Operation is subject to the condition that this device does not cause harmful interference.

Icom Inc.



**iDAS**  
ICOM DIGITAL ADVANCED SYSTEM



The photo shows the UHF transceiver.

---

## IMPORTANT

---

**READ ALL INSTRUCTIONS** carefully and completely before using the transceiver.

**SAVE THIS INSTRUCTION MANUAL** — This instruction manual contains important operating instructions for the **IC-F3161DT/IC-F3161DS VHF TRANSCEIVERS** and **IC-F4161DT/IC-F4161DS UHF TRANSCEIVERS**.

/// See the operating guide for details of IDAS™, BIIS, MDC and LTR® system operations. Ask your dealer for details.

Icom, Icom Inc. and the Icom logo are registered trademarks of Icom Incorporated (Japan) in Japan, the United States, the United Kingdom, Germany, France, Spain, Russia, Australia, New Zealand, and/or other countries.

IDAS is trademark of Icom Incorporated (Japan).

LTR is a registered trademark of the E.F.Johnson Technologies, INC. in the United States.

All other products or brands are registered trademarks or trademarks of their respective holders.

---

## EXPLICIT DEFINITIONS

---

WORD	DEFINITION
<b>⚠ DANGER!</b>	Personal death, serious injury or an explosion may occur.
<b>⚠ WARNING!</b>	Personal injury, fire hazard or electric shock may occur.
<b>CAUTION</b>	Equipment damage may occur.
<b>NOTE</b>	If disregarded, inconvenience only. No risk of personal injury, fire or electric shock.

---

## VOICE CODING TECHNOLOGY

---

The AMBE+2™ voice coding Technology embodied in this product is protected by intellectual property rights including patent rights, copyrights and trade secrets of Digital Voice Systems, Inc. This voice coding Technology is licensed solely for use within this Communications Equipment. The user of this Technology is explicitly prohibited from attempting to extract, remove, decompile, reverse engineer, or disassemble the Object Code, or in any other way convert the Object Code into a human-readable form. U.S. Patent Nos.

#5,870,405, #5,826,222, #5,754,974, #5,701,390, #5,715,365, #5,649,050, #5,630,011, #5,581,656, #5,517,511, #5,491,772, #5,247,579, #5,226,084 and #5,195,166.

---

## PRECAUTIONS

---

⚠ **DANGER! NEVER** short terminals of the battery pack. Also, current may flow into nearby metal objects such as a key, so be careful when placing the battery packs (or the transceiver) in handbags, etc.

Simply carrying with or placing near metal objects such as a key, etc. may cause shorting. This may damage not only the battery pack, but also the transceiver.

⚠ **DANGER!** Use and charge only specified Icom battery packs with Icom transceivers or Icom chargers. Only Icom battery packs are tested and approved for use with Icom transceivers or charged with Icom chargers. Using third-party or counterfeit battery packs or chargers may cause smoke, fire, or cause the battery to burst.

⚠ **DANGER!** In order to comply with the FM rating for gas, use of this transceiver is permitted in only a gas group D environment.

⚠ **WARNING! NEVER** hold the transceiver so that the antenna is very close to, or touching exposed parts of the body, especially the face or eyes, while transmitting. The transceiver will perform best if the microphone is 2 to 4 in. (5 to 10 cm) away from the lips and the transceiver is vertical.

⚠ **WARNING! NEVER** operate the transceiver while driving a vehicle. Safe driving requires your full attention—anything less may result in an accident.

⚠ **WARNING! NEVER** operate the transceiver with a headset or other audio accessories at high volume levels. The continuous high volume operation may cause a ringing in your ears. If you experience the ringing, reduce the volume level or discontinue use

**CAUTION: MAKE SURE** the flexible antenna, battery pack and jack cover are securely attached to the transceiver, and that the antenna and battery pack are dry before attachment. Exposing the inside of the transceiver to dust or water will result in serious damage to the transceiver.

**CAUTION: NEVER** use non-specified accessories and options. Using them invalidates the transceivers FM approval.

**CAUTION:** Changes or modifications to this transceiver, not expressly approved by Icom Inc., could void your authority to operate this transceiver under FCC regulations.

**DO NOT** push [PTT] when you do not actually intend to transmit.

**DO NOT** operate or place the transceiver in direct sunlight or in areas with temperatures below  $-4^{\circ}\text{F}$  ( $-20^{\circ}\text{C}$ ) or above  $+104^{\circ}\text{F}$  ( $+40^{\circ}\text{C}$ ).

**DO NOT** modify the transceiver. The specifications may change and then not comply with the requirements of a corresponded regulation. The transceiver warranty does not cover any problems caused by unauthorized modification.

**KEEP** the transceiver away from the heavy rain, and **Never** immerse it in the water. The transceiver is **water resistant**, not waterproof.

**DO NOT** use harsh solvents such as benzene or alcohol when cleaning, as they will damage the transceiver surfaces.

**BE CAREFUL!** The transceiver meets IP57 requirements for dust-protection and waterproof protection. However, once the transceiver has been dropped, dust-protection and waterproof protection cannot be guaranteed due to the fact that the transceiver may be cracked, or the waterproof seal damaged, etc.

**BE CAREFUL!** The transceiver will become hot when operating it continuously for long periods of time.

**MAKE SURE** to turn OFF the transceiver power before connecting or disconnecting the supplied/optional accessory.

Even when the transceiver power is OFF, a slight current still flows in the circuits. Remove the battery pack or batteries from the transceiver when not using it for a long time. Otherwise, the installed battery pack or batteries will become exhausted, and will need to be recharged or replaced.

---

## FCC INFORMATION

---

• **FOR CLASS A UNINTENTIONAL RADIATORS:**

This equipment has been tested and found to comply with the limits for a Class A digital device, pursuant to part 15 of the FCC Rules. These limits are designed to provide reasonable protection against harmful interference when the equipment is operated in a commercial environment. This equipment generates, uses, and can radiate radio frequency energy and, if not installed and used in accordance with the instruction manual, may cause harmful interference to radio communications.

Operation of this equipment in a residential area is likely to cause harmful interference in which case the user will be required to correct the interference at his own expense.

---

## INTRINSIC SAFETY

---



Versions of the IC-F3161DT/DS and IC-F4161DT/DS which display the “” marking on the label.

The approval rating for these models are;  
Intrinsically safe : Class I, II, III, Division 1,  
Groups D, E, F, G

Nonincendive : Class I, Division 2,  
Groups A, B, C, D

**WARNING! NEVER** charge the BP-232FM (with/without the transceiver) in an explosive atmosphere. The optional battery chargers are not approved as Intrinsically Safe.

When the transceiver is used in a hazardous area, the BP-232FM **MUST** be attached, either the jack cover or HM-169IS **MUST** be attached to the speaker-microphone connector.

**KEEP** the transceiver and the BP-232FM clean to avoid any risk of ignition due to the build-up of electrostatic charges.

Repair of Icom radios should only be carried out by authorized Icom distributors. In particular, repair of FM approved radios can **ONLY** be done by Icom to maintain the intrinsically safe rating. **NEVER** attempt to repair an FM approved radio. Only Icom has the repair expertise and procedures to maintain the FM approval. Contact your Icom distributor or authorised dealer for details.

---

# TABLE OF CONTENTS

---

IMPORTANT .....	i	■ Emergency transmission .....	17
EXPLICIT DEFINITIONS .....	i	■ Automatic Key Lock function .....	18
VOICE CODING TECHNOLOGY .....	i	■ Priority A channel selection .....	18
PRECAUTIONS .....	ii	<b>4 BATTERY CHARGING .....</b>	<b>19–23</b>
FCC INFORMATION .....	iii	■ Caution .....	19
INTRINSIC SAFETY .....	iii	■ Optional battery chargers .....	21
TABLE OF CONTENTS .....	iv	<b>5 SWIVEL BELT CLIP .....</b>	<b>24–25</b>
<b>1 ACCESSORIES .....</b>	<b>1–3</b>	■ MB-93 contents .....	24
■ Supplied accessories .....	1	■ To attach .....	24
■ Accessory attachments .....	1	■ To detach .....	25
<b>2 PANEL DESCRIPTION .....</b>	<b>4–10</b>	<b>6 SPEAKER MICROPHONE .....</b>	<b>26</b>
■ Front panel .....	4	■ Optional HM-169IS description .....	26
■ Function display .....	5	■ To attach .....	26
■ Programmable function keys .....	6	<b>7 OPTIONS .....</b>	<b>27–29</b>
<b>3 BASIC OPERATION .....</b>	<b>11–18</b>	<b>8 SAFETY TRAINING INFORMATION .....</b>	<b>30–32</b>
■ Turning power ON .....	11		
■ Channel selection .....	11		
■ Call procedure .....	13		
■ Receiving and transmitting .....	13		
■ User set mode .....	16		
■ Scrambler function .....	16		
■ Stun function .....	16		

1

2

3

4

5

6

7

8

## ■ Supplied accessories

The following accessories are supplied.

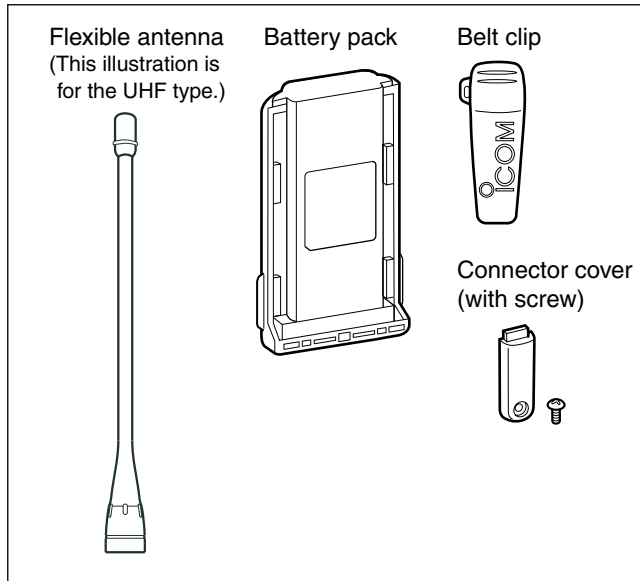

## ■ Accessory attachments

### ◇ Flexible antenna

Connect the supplied flexible antenna to the antenna connector.

### CAUTION:

- **NEVER** carry the transceiver by holding only the antenna.
- **DO NOT** connect the antenna other than listed on page 28.
- Transmitting without an antenna may damage the transceiver.



## ◇ Battery pack

### *To attach the battery pack:*

Slide the battery pack on the back of the transceiver in the direction of the arrow (❶), then lock it with the battery release button.

- Slide the battery pack until the battery release button makes a 'click' sound.

### *To remove the battery pack:*

Push the battery release button in the direction of the arrow (❷) as shown below. The battery pack is then removed.

/// **NEVER** remove or attach the battery pack when the transceiver is wet or soiled. This may result in water or dust getting into the transceiver/battery pack and may result in the transceiver being damaged.

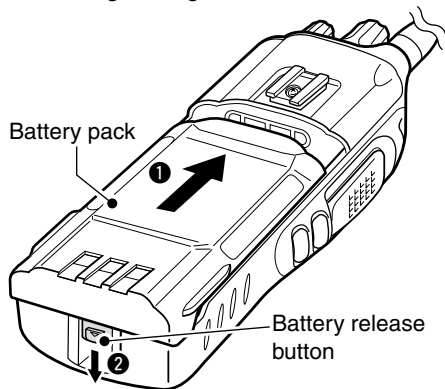

/// **NOTE:** Keep the battery pack terminals clean. It's a good idea to occasionally clean them.

## ◇ Belt clip

### *To attach the belt clip:*

- ❶ Remove the battery pack if it is attached.
- ❷ Slide the belt clip in the direction of the arrow until the belt clip is locked and makes a 'click' sound.

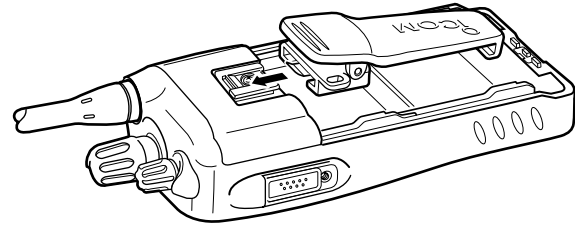

### *To detach the belt clip:*

- ❶ Remove the battery pack if it is attached.
- ❷ Pinch the clip (❶), and slide the belt clip in the direction of the arrow (❷).

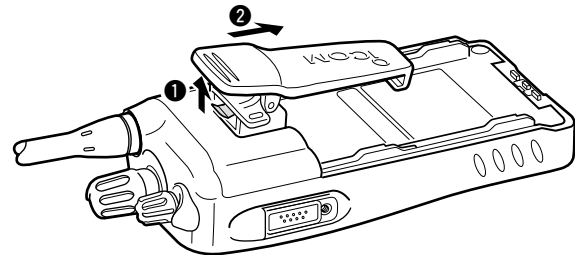

# 1 ACCESSORIES

## ◇ Connector cover

### *To attach the connector cover:*

- 1 Insert the connector cover into the multi-connector.
- 2 Tighten the screw.

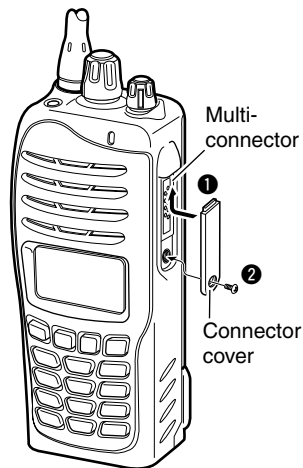

### *To detach the connector cover:*

- 1 Remove the screw using a phillips screwdriver.
- 2 Detach the connector cover for the optional equipment connector.

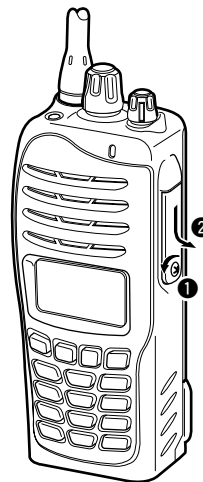

### **CAUTION:**

Attach the connector cover when the optional equipment is not used. Otherwise the terminals of the multi-connector may be shorted by metal object, etc., and this could damage the transceiver.



## ■ Front panel

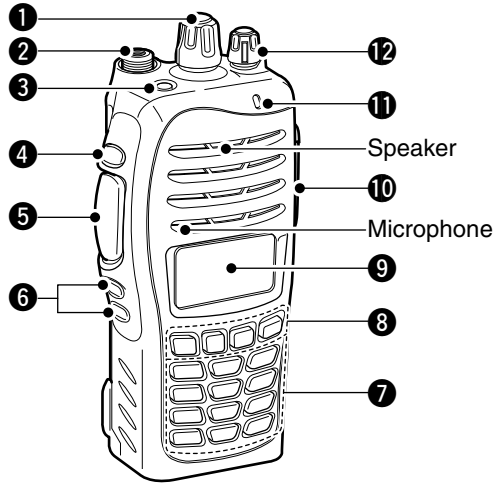

### 1 ROTARY SELECTOR

Rotate to select the pre-programmed memory channels or the operating zone. (Depending on the pre-setting)

### 2 ANTENNA CONNECTOR

Connects the supplied antenna. (p. 1)

### 3 DEALER-PROGRAMMABLE KEY [EMR]

Desired function can be programmed by your dealer. (p. 6)

### 4 DEALER-PROGRAMMABLE KEY [Side1]

Desired function can be programmed by your dealer. (p. 6)

### 5 PTT SWITCH [PTT]

Push and hold to transmit; release to receive.

### 6 DEALER-PROGRAMMABLE KEYS [Side2]/[Side3]

Desired function can be programmed independently by your dealer. (p. 6)

### 7 10-KEYPAD (Depending on version)

The keypad allows you to enter digits to:

- Select memory channels
- Select tone channels
- Select DTMF codes (during transmit)
- Set TX codes
- Start up with the password

### 8 DEALER-PROGRAMMABLE KEYS [P0] to [P3]

Desired function can be programmed independently by your dealer. (p. 6)

### 9 FUNCTION DISPLAY (p. 5)

Displays a variety of information such as an operating channel number/name, Set mode contents, DTMF code, selected function, etc.

## 2 PANEL DESCRIPTION

### ⑩ MULTI-CONNECTOR

Connect an optional equipment.

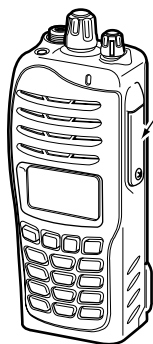

Connector cover

**NOTE:** Attach the connector cover when the optional equipment is not used. See page 3 for details.

### ① BUSY/TRANSMIT INDICATOR

- ➔ Lights green while receiving a signal, or when the squelch is open.
- ➔ Lights red while transmitting.

### ⑫ VOLUME CONTROL [VOL]

Rotate to turn the power ON/OFF and adjusts the audio level.

## ■ Function display

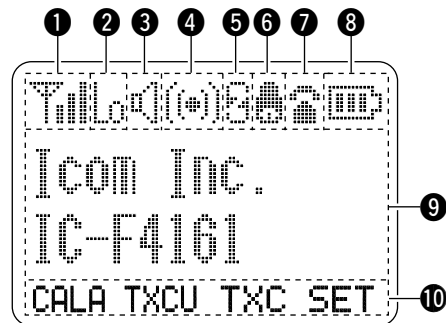

### ① SIGNAL STRENGTH INDICATOR

Indicates relative signal strength level.

### ② LOW POWER INDICATOR

Appears when low output power is selected.

### ③ AUDIBLE INDICATOR

- ➔ Appears when the channel is in the 'audible' (unmute) condition.
- ➔ Appears when the matched signal is received.

### ④ COMPANDER INDICATOR

Appears when the compander function is activated.

### ⑤ SCRAMBLER INDICATOR

Appears when the voice scrambler function is activated.

**6 BELL INDICATOR**

Appears/blinks when the matched signal is received, according to the pre-programming.

**7 CALL CODE MEMORY INDICATOR**

Appears when the call code memory is selected.

**8 BATTERY INDICATOR**

Appears or blinks when the battery power decreases to a specified level.

Indication				
Battery level	Full	Middle	Charging required	No battery

blinks when the battery is over charged.

blinks when the battery is exhausted.

**9 ALPHANUMERIC DISPLAY**

- Displays an operating channel number, channel name, Set mode contents, DTMF code, etc.
- The indication mode can be selected from 1 line or 2 lines. Ask your dealer for details.
  - In this instruction manual, the LCD illustration is described using the 2 lines indication mode.

**10 KEY INDICATOR**

Indicate the programmed function of the front panel keys ([P0], [P1], [P2] and [P3]).

**Programmable function keys**

The following functions can be assigned to [EMR], [Side1], [Side2], [Side3], [P0], [P1], [P2] and [P3] programmable function keys.

Consult your Icom dealer or system operator for details concerning your transceivers programming.

If the programmable function names are bracketed in the following explanations, the specific key is used to activate the function depends on the programming.

**CH UP AND DOWN KEYS “UP” “DOWN”**

- Push to select an operating channel. When [Rotary selector] selects “operating channel,” this key is not available.
- Push to select a transmit code channel after pushing [TX Code CH Select].
- Push to select a DTMF channel after pushing [DTMF Audiotail].
- Push to select a scan group after pushing and holding [Scan].
- Push to select the desired application type, individual/talk-group ID, TX status message and SDM (Short Data Message) after pushing [Digital Button].

---

## 2 PANEL DESCRIPTION

### **ZONE KEY “ZONE”**

Push this key, then push [CH Up] or [CH Down] to select the desired zone. When [Rotary selector] selects “operating zone,” this key operation is not available.

 **What is “zone”?**— Selected channels are assigned to a zone according to how they are to be used in a group. For example, ‘Staff A’ and ‘Staff B’ are assigned into a “Business” zone, and ‘John’ and ‘Cindy’ are assigned into a “Private” zone.

### **ZONE UP AND DOWN KEYS “ZNUF” “ZNDN”**

Push to select an operating zone. When [Rotary selector] selects “operating zone,” this key is not available.

### **SCAN KEY “SCAN”**

- ➔ Push to start and cancel scanning operation.
  - When Power ON Scan function is activated, push to pause the scanning operation. And the paused scan restarts after the specified time period has passed.
- ➔ Push and hold this key for 1 sec. to indicate the scan list, then push [CH Up] or [CH Down] to select the desired list.

### **SCAN ADD/DEL (TAG) KEY “SCAD”**

- ➔ Push to add channel to, or delete it from the current scan group.
  1. Push to indicate the scan group, then push [CH Up] or [CH Down] to select the desired group.
  2. Push to add or delete the channel to/from the selected scan group.
  3. Push and hold for 1 sec. to exit the scan group selection mode.
- ➔ Push this key while scan is paused (a signal is detected) on a channel (except for priority channel,) the channel is cleared from the scan group.

 Depending on the setting, the cleared channel is added to the scan group again after the scan is cancelled.  
(Nuisance Delete function)

### **PRIORITY CHANNEL KEYS “PRA” “PRAR” “PRB” “PRBR”**

- ➔ Push to select Priority A or Priority B channel.
- ➔ Push and hold [Prio A (Rewrite)] or [Prio B (Rewrite)] for 1 sec. to rewrite the Priority A or Priority B channel for the operating channel.

**MEMORY CH 1/2/3/4 KEYS** “CH1” “CH2” “CH3” “CH4”

Push to select the memory channels 1 to 4 directly.

**MONI KEY** “MON”

- Push to mute and release the CTCSS (DTCS) or 2-Tone squelch mute. Open any squelch/deactivate any mute while pushing and holding this key. (LMR operation only)
- Activates one of (or two of) the following functions on each channel independently: (PMR operation only)
  - Push and hold to un-mute the channel (audio is emitted; ‘Audible’ condition).
  - Push to mute the channel (sets to ‘Inaudible’ only).
  - Push after the communication is finished to send a ‘reset code’. (5-Tone/BIS operation only)

 **NOTE:** The un-mute condition (‘Audible’ condition) may automatically return to the mute condition (‘Inaudible’ condition) after a specified period.

**LIGHT KEY** “LIGT”

Push to turn the transceiver’s backlight ON temporarily only when the backlight function is turned OFF in user set mode.

**LOCK KEY** “LOCK”

- Push and hold for 1 sec. to electronically lock all programmable keys for preventing accidental frequency changes and unnecessary function access except the following: [PTT], [Call] (incl. Call A and Call B), [Moni(Audi)], [Light], [Emergency], [Surveillance], [Lone Worker] and [OPT 1/2/3].
- Push and hold for 1 sec. again to turn the lock function OFF.

**LONE WORKER KEY** “LONE”

Push to turn the Lone Worker function ON or OFF.

- If the Lone Worker function is activated, the Emergency function is automatically turned ON after the specified time period has passed with no operation is performed.

**HIGH/LOW KEY** “H/L”

Push to select the transmit output power temporarily or permanently, depending on the pre-setting.

- Ask your dealer for the output power level for each selection.

**TONE/RAN CH SELECT KEY** “T SEL”

- While in analog mode operation, push to enter the continuous tone channel selection mode. Then select the desired tone frequency/code setting with [CH Up] or [CH Down]. After the selection, push this key again to set.
- While in digital mode operation, push to enter the RAN channel selection mode. Then select the desired RAN setting with [CH Up] or [CH Down]. After the selection, push this key again to set.
- While in mixed (digital and analog) mode operation, push to enter the continuous tone channel selection mode. Then select the desired tone frequency/code setting with [CH Up] or [CH Down]. After the selection, push this key to set. After that, the RAN channel selection screen appears. Select the desired RAN setting with [CH Up] or [CH Down]. After the selection, push this key again to set.

---

## 2 PANEL DESCRIPTION

### **TALK AROUND KEY** “TA”

Push to turn the talk around function ON and OFF.

- The talk around function equalizes the transmit frequency to the receive frequency for transceiver-to-transceiver communication.

### **WIDE/NARROW KEY** “W/N”

Push to toggle the IF bandwidth between wide and narrow.

### **DTMF AUTODIAL KEY** “DTMA”

Push to enter the DTMF channel selection mode. Then select the desired DTMF channel using [CH Up]/[CH Down]. After selecting the DTMF channel, push again to transmit the selected DTMF code.

### **RE-DIAL KEY** “DTMR”

Push to transmit the last-transmitted DTMF code.

### **CALL KEYS** “CALL” “CALA” “CALB”

Push to transmit a 2/5-Tone or BIIS ID code.

- Call transmission is necessary before you call another station depending on your signaling system.
- [Call A] and/or [Call B] may be available when your system employs selective ‘Individual/Group’ calls. Ask your dealer which call is assigned to each key.

### **EMERGENCY KEY** “EMR”

Push and hold to transmit the emergency call.

- The emergency call transmits with beeps; the display does not change.
- The transceiver can transmit the emergency call silently or with the display changes depending on the pre-setting. Ask your dealer for details.
- If you want to cancel the emergency call, push and hold the key again before transmitting the call.
- The emergency call is transmitted one time only or repeatedly until receiving a control code, depending on the pre-setting.

### **SURVEILLANCE KEY** “SURV”

Push to turn the surveillance function ON or OFF.

When this function is turned ON, the beep is not emitted and the LCD backlight does not light when a signal is received or a key is pushed, etc.

### **TX CODE ENTER KEYS** “TXCE”

Push to enter the ID code edit mode directly, for both 5-Tone and MSK. Then set the desired digit using [CH Up]/[CH Down]. (p. 15)

### **TX CODE CHANNEL SELECT KEY** “TXC”

Push to enter the TX code channel selection mode. Then set the desired channel using [CH Up]/[CH Down]. (pp. 14, 15)

**TX CODE CHANNEL UP/DOWN KEYS** "TXCU" "TXCD"

Push to select a TX code channel directly.

**ID-MEMORY SELECT KEY** "IDMS"

- Recalls detected ID codes.
  - Push this key, then select the ID code using [CH Up]/[CH Down].
  - Up to 5 ID's are memorized.
- Push and hold for 1 sec. to erase the selected ID's.

**SCRAMBLER/ENCRYPTION KEY** "SCR"

- While in the analog mode operation, push to toggle the voice scrambler function ON and OFF.
- While in the digital mode operation, push to toggle the encryption transmission function ON and OFF.

**COMPANDER KEY** "COMP"

Push to toggle the compander function ON and OFF.

The compander function reduces noise components from the transmitting audio to provide clear communication.

**USER SET MODE KEY** "SET"

- Push and hold for 1 sec. to enter user set mode.
  - During user set mode, push this key to select an item that is enabled by your dealer, and change the value or condition using push [CH Up]/[CH Down].
- Push and hold this key for 1 sec. again to exit user set mode.

**OPT OUT KEYS** "OP1" "OP2" "OP3"

Push to control the output signal level from the optional unit connector.

**OPT MOMENTARY KEYS** "O1M" "O2M" "O3M"

Push to control the output signal level from the optional unit connector.

## ■ Turning power ON

 Prior to using the transceiver for the first time, the battery pack must be fully charged for optimum life and operation. (p. 19)

- ① Rotate [VOL] to turn the power ON.
- ② If the transceiver is programmed for a start up password, input the digit codes as directed by your dealer.
  - 10-keypad can be used for password input depending on version.
  - The keys in the table below can be used for password input.
  - The transceiver detects numbers in the same block as identical. Therefore “01234” and “56789” are the same.

KEY	<b>P<sub>0</sub></b>	<b>P<sub>1</sub></b>	<b>P<sub>2</sub></b>	<b>P<sub>3</sub></b>	<b>(Side1)</b>
<b>NUMBER</b>	0	1	2	3	4
	5	6	7	8	9

- ③ When the “PASSWORD” indication does not clear after inputting 6 digits, the input code number may be incorrect. Turn the power off and start over in this case.

## ■ Channel selection

Several types of channel selections are available. Methods may differ according to your system set up.

### **NON-ZONE TYPE:**

To select the desired operating channel:

- Push [CH Up] or [CH Down].
- Rotate [ROTARY SELECTOR]\*.
  - Up to pre-programmed 16 channels can be selected.
- Push one of [MR-CH 1] to [MR-CH 4].

### **ZONE TYPE:**

To select the desired zone:

- Push [Zone], then push [CH Up] or [CH Down].
- Push [Zone Up] or [Zone Down].
- Rotate [ROTARY SELECTOR]\*.
  - Up to pre-programmed 16 zones can be selected.

### ◇ **Voting operation**

The transceiver automatically starts scanning when a zone, specified for the voting operation, is selected.

The voting scan detects the S-meter of the repeater and automatically selects the strongest station.



**AUTOMATIC SCAN TYPE:**

Channel setting is not necessary for this type. When turning power ON, the transceiver automatically starts scanning. Scanning stops when receiving a call.

\* Depending on the pre-setting.

When [Rotary selector] selects "Operating channel," [CH Up]/[CH Down] are not available.

When [Rotary selector] selects "Operating zone," [Zone]/[Zone Up]/[Zone Down] are not available.

### 3 BASIC OPERATION

## ■ Call procedure

When your system employs tone signalling (excluding CTCSS and DTCSS), this call procedure may be necessary prior to voice transmission. The tone signalling employed may be a selective calling system which allows you to call specific station(s) only and prevent unwanted stations from contacting you.

- ① Select the desired TX code channel or 2/5-Tone code according to your System Operator's instructions.
  - This may not be necessary depending on programming.
  - Refer to pages 14 or 15 for selection.
- ② Push [Call] (assigned to one of the dealer programmable keys)
- ③ After transmitting, the remainder of your communication can be carried out in the normal fashion.

*Selective calling*

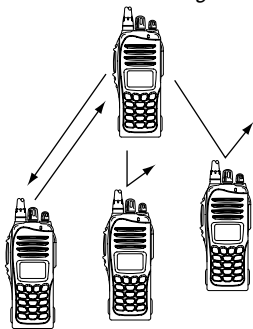

*Non-selective calling*

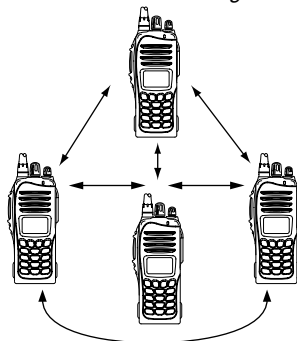

## ■ Receiving and transmitting

**CAUTION:** Transmitting without an antenna may damage the transceiver. See page 1 for accessory attachments.

### **Receiving:**

- ① Rotate [VOL] to turn the power ON.
- ② Push [CH Up] or [CH Down], or rotate [ROTARY SELECTOR]\* to select the conventional system channel, in sequence.
  - \*Depending on the pre-setting.
- ③ When receiving a call, adjust the audio output level to a comfortable listening level.

**NOTE:** When a matched RX code signal is received, audio from the microphone is automatically transmitted for a specified time period.\*

\* Depending on the presetting. Ask your dealer for details.

### **Transmitting:**

Wait for the channel to become clear to avoid interference.

- ① While pushing and holding [PTT], speak into the microphone at a normal voice level.
  - When a tone signalling system is used, the call procedure described at the previous page may be necessary.
- ② Release [PTT] to return to receive.

**IMPORTANT:** To maximize the audio quality of your signal;

1. Pause briefly after pushing [PTT].
2. Hold the microphone 5 to 10 cm (2 to 4 inches) from your mouth, then speak into the microphone at a normal voice level.

### ◇ Transmitting notes

#### • Transmit inhibit function

The transceiver has several inhibit functions which restrict transmission under the following conditions:

- The channel is in mute condition ('Inaudible' condition; "🔇" (Audible indicator) does not appear.)
- The channel is busy.
- Un-matched (or matched) CTCSS is received. (Depending on the pre-setting.)
- The selected channel is a 'receive only' channel.

#### • Time-out timer

After continuous transmission for the pre-programmed time period, the time-out timer starts, causing the transceiver to stop transmitting.

#### • Penalty timer

Once the time-out timer starts, transmission is further inhibited for a period determined by the penalty timer.

### ◇ TX code channel selection

If the transceiver has [TX Code CH Select] assigned to it, the indication can be toggled between the operating channel number (or name) and TX code channel number (or name). When the TX code channel number (or name) is displayed, [CH Up] or [CH Down] selects the TX code channel.

#### **USING [TX CODE CH SELECT] KEY:**

- ① Push [TX Code CH Select]— a TX code channel number (or name) appears.
- ② Push [CH Up] or [CH Down] to select the desired TX code channel.
- ③ After selecting, push [TX Code CH Select] to set.
  - Return to the stand-by mode.
- ④ Push [Call] to transmit the selected TX code.

#### **USING [TX CODE CH UP]/[TX CODE CH DOWN] KEY:**

If the transceiver has a [TX Code CH Up] or [TX Code CH Down] key assignment, the programmed TX code channel can be selected directly when pushed.

➡ Continue to the next page

---

## 3 BASIC OPERATION

### ◇ TX code number edit (PMR operation only)

If the transceiver has [TX Code CH Select] or [TX Code Enter] assigned to it, TX code contents can be edited within the allowable digits.

#### **USING [TX CODE CH SELECT] KEY:**

- ① Push [TX Code CH Select] to enter the TX code channel selection mode.
  - Select the desired operating channel before entering the TX code channel selection mode if necessary.
- ② Push [TX Code CH Select] for 1 sec. to enter the TX code edit mode.
  - The digit to be edited blinks.
- ③ Push [TX Code CH Select] to select the desired digit to be edited.
- ④ Push [CH Up]/[CH Down] to select the desired digit.
- ⑤ Push [TX Code CH Select] to set. The digit to the right will blink automatically.
- ⑥ Repeat ④ and ⑤ to edit all allowable digits.
- ⑦ After editing, push [TX Code CH Select] to set.
  - Return to the stand-by mode.
- ⑧ Push [Call] to transmit.

#### **USING [TX CODE ENTER] KEY:**

- ① After pushing [TX Code CH Select], push [CH Up] or [CH Down], or push [TX Code CH Up] or [TX Code CH Down] to select the desired TX code channel.
- ② Push [TX Code Enter] to enter the TX code edit mode.
  - The digit to be edited blinks.
- ③ Push [TX Code Enter] to select the desired digit to be edited.
- ④ Push [CH Up]/[CH Down] to select the desired digit.
- ⑤ Push [TX Code Enter] to set. The digit to the right will blink automatically.
- ⑥ Repeat ④ and ⑤ to edit all allowable digits.
- ⑦ After editing, push [TX Code Enter] to set.
  - Return to the stand-by mode.
- ⑧ Push [Call] to transmit.

### ◇ DTMF transmission

If the transceiver has [DTMF Autodial] assigned to it, the automatic DTMF transmission function is available. Up to 8 DTMF channels are available.

- ① Push [DTMF Autodial]— a DTMF channel appears.
- ② Push [CH Up] or [CH Down] to select the desired DTMF channel.
- ③ Push [DTMF Autodial] to transmit the DTMF code.

## ■ User set mode

The User Set mode allows you to set seldom-changed settings. If the transceiver has [User Set Mode] assigned to it, you can “customize” the transceiver operation to suit your preferences and operating style.

### **Entering the user set mode:**

- ① Push and hold [User Set Mode] to enter the User Set mode.
- ② Push [User Set Mode] several times to select the appropriate item. Then push [CH Up] or [CH Down] to set the desired level/condition.
  - In the User Set mode, the selectable items are preset by your dealer. The presettable items are **Backlight**, **LCD contrast**, **Beep**, **Beep Level**, **Ringer Level**, **SQL Level**, **AF Min Level**, **Mic Gain**, **VOX Gain\***, **VOX Delay\***, **Battery Voltage**, **Signal Moni**, **Lone Worker** and **System Info**.
  - \* Appears only when the external VOX unit is connected.
- ③ Push and hold [User Set Mode] again to exit the User Set mode.

## ■ Scrambler function

The voice scrambler function provides private communication between stations. All versions have a built-in frequency inversion type scrambler.

- ➔ Push [Scrambler] to toggle the scrambler function ON or OFF.
  - “” (Scrambler indicator) appears when the function is ON.

## ■ Stun function

When the specified ID, set as a stun ID or kill ID, is received, the stun function is activated.

When the stun ID is received, the transceiver becomes unusable. Entering of the password (p. 11) or receiving a specified ID, set as a revive ID, is necessary to operate the transceiver again in this case.

When the kill ID is received, the transceiver switches to the cloning required condition. Cloning the transceiver is necessary to operate the transceiver again in this case.

---

## 3 BASIC OPERATION

### ■ Emergency transmission

When [Emergency] is pushed for the specified time period\*, the emergency signal is transmitted once, or repeatedly, on the specified emergency channel.

A repeat emergency signal is automatically transmitted until the transceiver receives an acknowledgement signal, or you turn the transceiver power OFF.

When no emergency channel is specified, the signal is transmitted on the operating channel.

If you want to cancel the emergency call, push and hold [Emergency] again before transmitting the call.

If your transceiver is programmed for Silent operation, you can transmit an Emergency call without the beep sounding and the LED indicator lighting.

**IMPORTANT:** It is recommended to set an emergency channel individually to provide the certain emergency call operation.

\* Depending on the presetting. Ask your dealer for details.

### ◇ NOTES

Depending on the presetting, the following functions are automatically activated. Ask your dealer for details.

#### • Auto TX function

After the emergency call transmission, audio from the microphone is automatically transmitted for a specified time period.\*

#### • Auto RX function

After the emergency call transmission, the transceiver stands by in the audible mode for the specified time period.\*

## ■ Automatic Key Lock function

When [Lock] is assigned to any key and the Automatic Key Lock timer is pre-programmed\* by your dealer, the key lock function can be automatically turned ON after the specified time period has passed without operation during standby condition.

While the lock function is ON, push and hold [Lock] for 1 sec. to turn the function OFF.

\*When "0" is programmed, this function is not available.

## ■ Priority A channel selection

When one of the following operations is performed, the transceiver selects the Priority A channel automatically.

- Turning the power ON  
The Priority A channel is selected each time the transceiver power is turned ON.
- Status call  
The Priority A channel is selected when transmitting a status call. (BIIS operation only)
- Clear down  
The Priority A channel is selected after the clear down signal is transmitted.

## ■ Caution

- Misuse of Li-ion batteries may result in the following hazards: smoke, fire, or the battery may rupture. Misuse can also cause damage to the battery or degradation of battery performance.
- Prior to using the battery pack for the first time, or after not using it for a long time, you must fully charge the pack. Otherwise, the transceiver may not turn ON.

### ◇ Battery caution

⚠ **DANGER! DO NOT** hammer or otherwise impact the battery. Do not use the battery if it has been severely impacted or dropped, or if the battery has been subjected to heavy pressure. Battery damage may not be visible on the outside of the case. Even if the surface of the battery does not show cracks or any other damage, the cells inside the battery may rupture or catch fire.

⚠ **DANGER! NEVER** use or leave battery packs in areas with temperatures above +40°C (+104°F). High temperature buildup in the battery, such as could occur near fires or stoves, inside a sun heated car, or in direct sunlight may cause the battery to rupture or catch fire. Excessive temperatures may also degrade battery performance or shorten battery life.

⚠ **DANGER! DO NOT** expose the battery to rain, snow, seawater, or any other liquids. Never charge or use a wet battery. If the battery gets wet, be sure to wipe it dry before using. The battery is not waterproof.

⚠ **DANGER! NEVER** incinerate used battery packs since internal battery gas may cause them to rupture, or may cause an explosion.

⚠ **DANGER! NEVER** solder the battery terminals or NEVER modify the battery pack. This may cause heat generation, and the battery may rupture, emit smoke or catch fire.

⚠ **DANGER!** Use the battery only with the transceiver for which it is specified. Never use a battery with any other equipment, or for any purpose that is not specified in this instruction manual.

⚠ **DANGER!** If fluid from inside the battery gets in your eyes, blindness can result. Rinse your eyes with clean water, without rubbing them, and see a doctor immediately.

⚠ **WARNING!** Immediately stop using the battery if it emits an abnormal odor, heats up, or is discolored or deformed. If any of these conditions occur, contact your Icom dealer or distributor.

⚠ **WARNING!** Immediately wash, using clean water, any part of the body that comes into contact with fluid from inside the battery.

⚠ **WARNING! NEVER** put the battery in a microwave oven, high-pressure container, or in an induction heating cooker. This could cause a fire, overheating, or cause the battery to rupture.

**CAUTION:** Always use the battery within the specified temperature range (–20°C to +40°C; –4°F to +104°F). Using the battery out of its specified temperature range will reduce the battery's performance and battery life.



**CAUTION:** Shorter battery life could occur if the battery is left fully charged, completely discharged, or in an excessive temperature environment (above +40°C; +104°F) for an extended period of time. If the battery must be left unused for a long time, it must be detached from the transceiver after discharging. You may use the battery until the remaining capacity is about half, then keep it safely in a cool dry place with the temperature range as below:

-20°C to +40°C (-4°F to +104°F) (within a month)

-20°C to +35°C (-4°F to +95°F) (within three months)

-20°C to +20°C (-4°F to +68°F) (within a year)

**BE SURE** to replace the battery pack with a new one approximately five years after manufacturing, even if it still holds a charge. The inside battery material will become weak after a period of time, even with little use. The estimated number of times you can charge the battery is between 300 and 500.

Even when the battery appears to be fully charged, the operating time of the transceiver may become short when:

- Approximately five years have passed since the battery was manufactured.
- The battery has been repeatedly charged.

### ◇ Charging caution

⚠ **DANGER! NEVER** charge the battery pack in areas with extremely high temperatures, such as near fires or stoves, inside a sun heated car, or in direct sunlight. In such environments, the safety/protection circuit in the battery will activate, causing the battery to stop charging.

⚠ **DANGER! NEVER** charge the battery pack in areas with explosive atmospheres.

⚠ **WARNING! NEVER** charge or leave the battery in the battery charger beyond the specified time for charging. If the battery is not completely charged by the specified time, stop charging and remove the battery from the battery charger. Continuing to charge the battery beyond the specified time limit may cause a fire, overheating, or the battery may rupture.

⚠ **WARNING! NEVER** insert the transceiver (battery attached to the transceiver) into the charger if it is wet or soiled. This could corrode the battery charger terminals or damage the charger. The charger is not waterproof.

**CAUTION: NEVER** charge the battery outside of the specified temperature range with BC-160 (0°C to +45°C; +32°F to +113°F).

Icom recommends charging the battery at +20°C (+68°F). The battery may heat up or rupture if charged out of the specified temperature range. Additionally, battery performance or battery life may be reduced.

## 4 BATTERY CHARGING

### ■ Optional battery chargers

#### ◇ Rapid charging with the BC-160

The optional BC-160 provides rapid charging of the Li-ion battery pack.

Charging period: Approximately 3 hours (with BP-232FM)

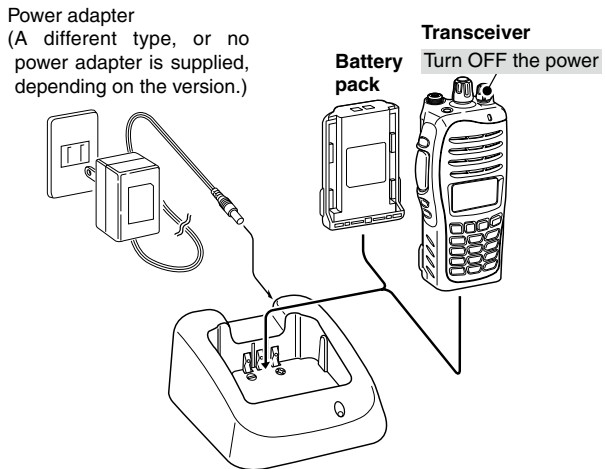

#### ◇ Regular charging with the BC-171

The optional BC-171 provides regular charging of the Li-ion battery pack.

Charging period: Approximately 10 hours (with BP-232FM)

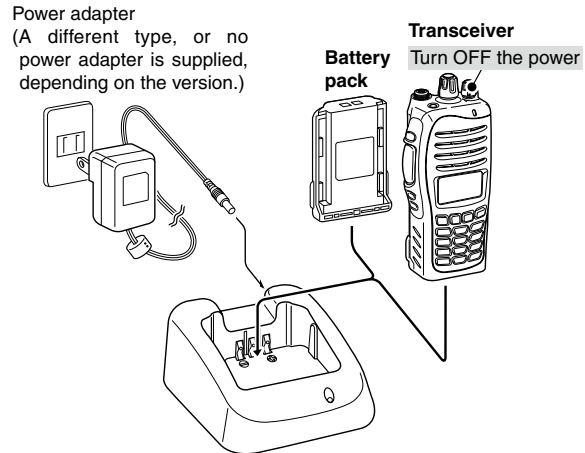

◇ **AD-106 installation**

The AD-106 CHARGER ADAPTER must be installed into the BC-119N or BC-121N before battery charging.

Connect the AD-106 and the BC-119N/BC-121N as shown below, then install the AD-106 into the holder space of the BC-119N or BC-121N with the supplied screws.

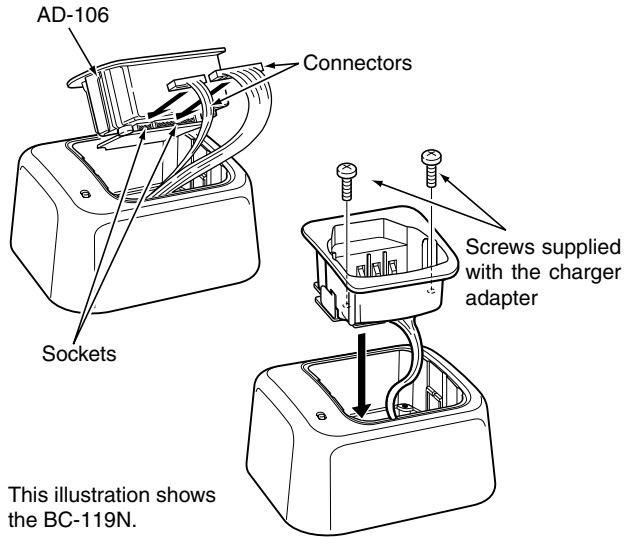

◇ **Rapid charging with the BC-119N+AD-106**

The optional BC-119N provides rapid charging of the Li-ion battery pack.

Charging period: Approximately 3 hours (with BP-232FM)

The following item is additionally required.

- AD-106 CHARGER ADAPTER (purchase separately)

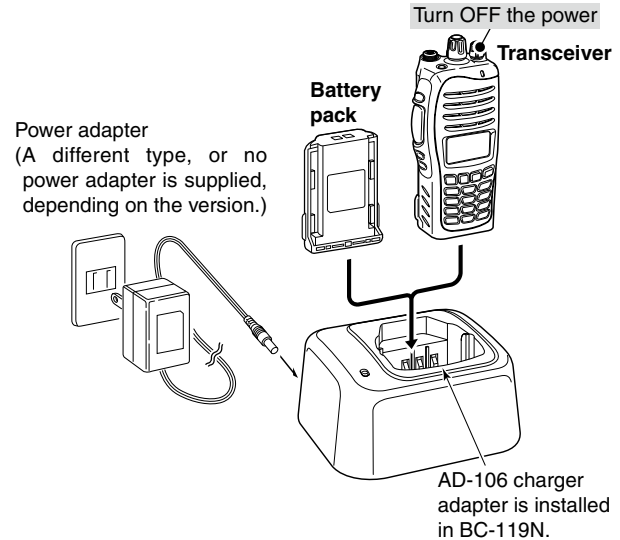

## 4 BATTERY CHARGING

### ◇ Rapid charging with the BC-121N+AD-106

The optional BC-121N allows up to 6 battery packs to be charged simultaneously.

Charging period: Approximately 3 hours (with BP-232FM)

The following items are additionally required.

- Six AD-106 CHARGER ADAPTERS (purchase separately)
- A power adapter or the DC power cable (OPC-656)

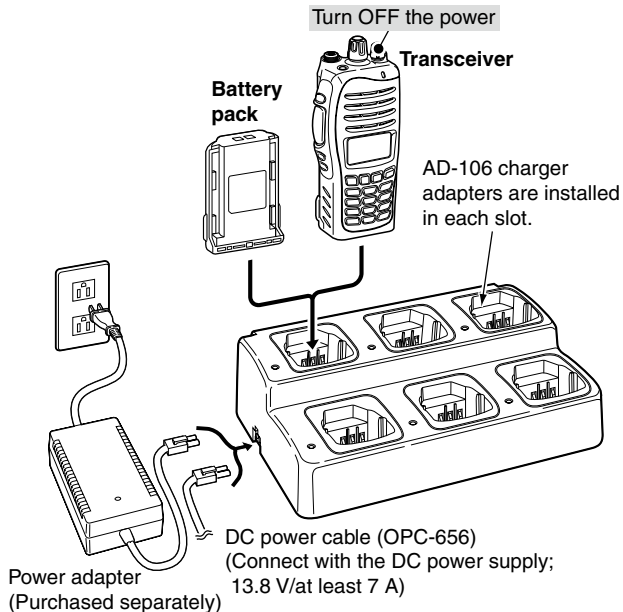

### IMPORTANT: Battery charging caution

Ensure the guide tabs on the battery pack are correctly aligned with the guide rails inside the charger adapter.  
(This illustration is described with the BC-160.)

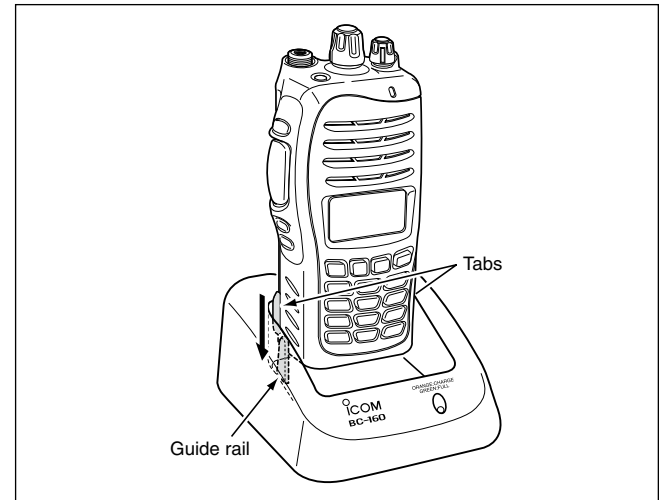

### CAUTION:

When using the OPC-656 DC power cable  
**NEVER** reverse the polarity when connecting the OPC-656 to a power source. This will ruin the battery charger.

Red line: ⊕, Black line: ⊖

## ■ MB-93 contents

	Qty.
① Belt clip .....	1
② Base clip .....	1

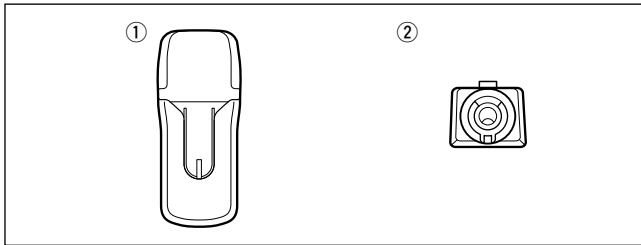

## ■ To attach

- ① Remove the battery pack if it is attached. (p. 2)
- ② Slide the base clip in the direction of the arrow until the base clip is locked and makes a 'click' sound.

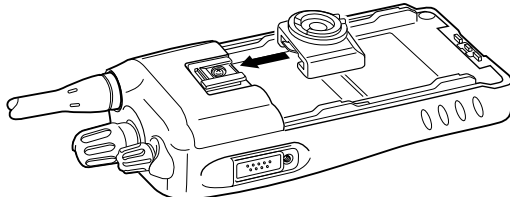

- ③ Attach the battery pack. (p. 2)

- ④ Clip the belt clip to a part of your belt. And insert the transceiver into the belt clip until the base clip inserted fully into the groove.

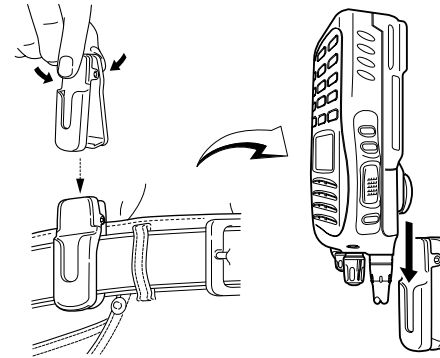

- ⑤ Once the transceiver is locked in place, it swivels as illustrated below.

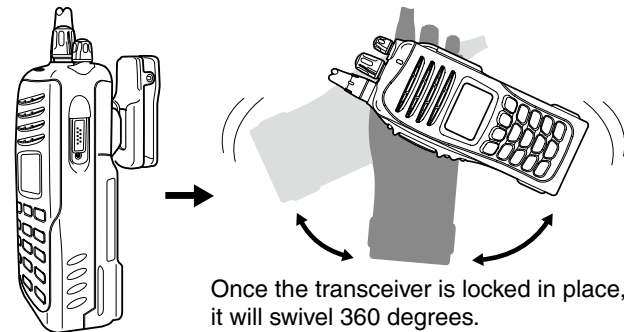

## 5 SWIVEL BELT CLIP

### ■ To detach

- ① Turn the transceiver upside down in the direction of the arrow and pull out from the belt clip.

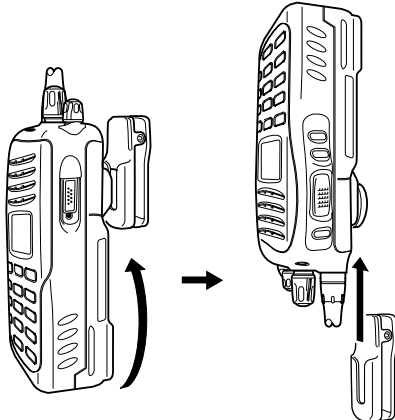

- ② Remove the battery pack if it is attached. (p. 2)
- ③ Pinch the clip (①), and slide the base clip in the direction of the arrow (②).

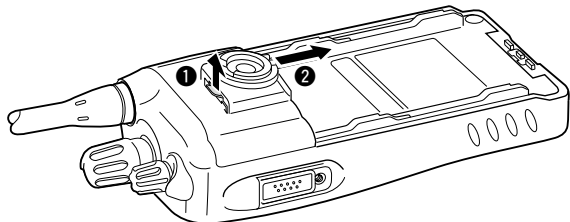

**CAUTION:**  
HOLD THE TRANSCEIVER TIGHTLY, WHEN HANGING OR DETACHING THE TRANSCEIVER FROM THE BELT CLIP.

Otherwise the transceiver may not be attached to the holder or swivel properly if the transceiver is accidentally dropped and the base clip is scratched or damaged.

## Optional HM-169IS description

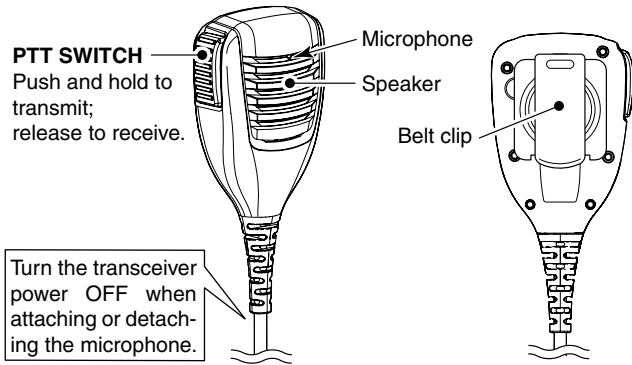

**NEVER** immerse the connector in water. If the connector becomes wet, be sure to dry it **BEFORE** attaching it to the transceiver.

**NOTE:** The microphone is located at the top of the speaker-microphone, as shown in the diagram above. To maximize the readability of your transmitted signal (voice), hold the microphone approximately 5 to 10 cm (2 to 4 inches) from your mouth, and speak in a normal voice level.

## To attach

Attach the connector of the speaker-microphone into the multi connector on the transceiver and tighten the screw.

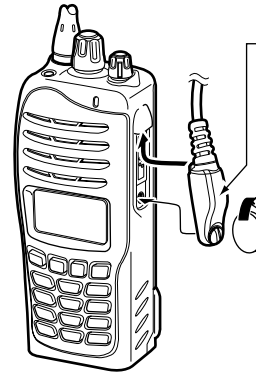

**CAUTION:** Attach the multi connector snugly, but do not overtighten. A loose connection will allow water intrusion into the connector; an overtightened connector will damage the connector pins in the transceiver.

**IMPORTANT: KEEP** the connector cover attached to the transceiver when the speaker-microphone is not in use. (p. 3)  
Water will not get into the transceiver even if the cover is not attached, however, the terminals (pins) will become rusty, or the transceiver will function abnormally if the connector becomes wet.

### ◇ BATTERY PACKS

Battery pack	Voltage	Capacity	Battery life*
<b>BP-232FM</b>	7.4 V	1900 mAh (min.) 2000 mAh (typ.)	12 hrs.

\*When the power save function is turned ON, and the operating periods are calculated under the following conditions;  
TX : RX : standby = 5 : 5 : 90

### ◇ CHARGERS

- **BC-119N** DESKTOP CHARGER + **AD-106** CHARGER ADAPTER + **BC-145SA** AC ADAPTER  
For rapid charging of battery pack. A power adapter is supplied with the charger.  
Charging time: Approximately 3 hours
- **BC-121N** MULTI-CHARGER + **AD-106** CHARGER ADAPTER (6 pcs.) + **BC-157S** AC ADAPTER  
For rapid charging of up to 6 battery packs (six AD-106s are required) simultaneously. A power adapter should be purchased separately.  
Charging time: Approximately 3 hours
- **BC-160** DESKTOP CHARGER + **BC-145SA** AC ADAPTER  
For rapid charging of battery pack. A power adapter is supplied with the charger.  
Charging time: Approximately 3 hours
- **BC-171** DESKTOP CHARGER + **BC-147SA** AC ADAPTER  
For regular charging of battery packs. A power adapter is supplied with the charger.  
Charging time: Approximately 10 hours

### ◇ BELT CLIPS

- **MB-93** SWIVEL BELT CLIP
- **MB-94** BELT CLIP  
Exclusive alligator-type belt clip.
- **MB-96N/MB-96F** LEATHER BELT HANGER

### ◇ OTHER OPTIONS

- **OPC-656** DC POWER CABLE  
Allows the BC-121N charging of the battery pack using a 13.8 V power source instead of the power adapter.
- **HM-169IS** SPEAKER-MICROPHONE  
Rugged type speaker-microphone.
- **VS-1SC** VOX/PTT CASE + **HS-94/HS-95/HS-97** HEADSET  
VS-1SC: VOX/PTT switch box for hands-free operation, etc.  
HS-94 : Ear-hook type  
HS-95 : Neck-arm type  
HS-97 : Throat microphone
- **MB-130** VEHICLE CHARGER BRACKET  
Vehicle mounting bracket for the BC-160 battery charger.



◇ **ANTENNAS**

• **FA-SC25V/FA-SC55V**

**FA-SC25U/FA-SC57U/FA-SC72U** FLEXIBLE ANTENNAS  
VHF or UHF antennas.

FA-SC25V: Frequency range 136–150 MHz

FA-SC55V: Frequency range 150–174 MHz

FA-SC25U: Frequency range 400–430 MHz

FA-SC57U: Frequency range 430–470 MHz

FA-SC72U: Frequency range 470–520 MHz

• **FA-SC61VC/FA-SC61UC** CUT ANTENNAS

FA-SC61VC: Frequency range 136–174 MHz

FA-SC61UC: Frequency range 380–520 MHz

The BP-232FM and HM-169IS conform to the intrinsically safe ratings of the FM Approvals. Any other options, except the antenna, VOX/PTT case, headset, belt clip and belt hanger, cannot be used in explosive atmosphere areas.

Approved Icom optional equipment is designed for optimal performance when used with an Icom transceiver.

Icom is not responsible for the destruction or damage to an Icom transceiver in the event the Icom transceiver is used with equipment that is not manufactured or approved by Icom.

◇ **About VS-1SC VOX/PTT CASE**

The VS-1SC is a VOX/PTT unit for Icom handheld transceivers, and allows you hands-free operation.

An optional headset (HS-94/HS-95/HS-97) is required for operation.

- The VOX (Voice Operated Transmission) function starts transmission without pushing PTT switch when you speak into the microphone; then, automatically returns to receive when you stop speaking.

**Features**

- 9-pin Spring-plug type head SP/MIC plug is equipped
- Water resistant construction
- Durable construction
- Equipped with a PTT switch and revolving clip

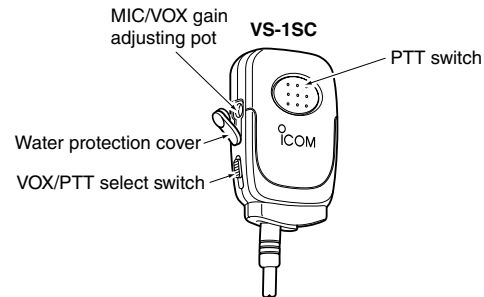

## 7 OPTIONS

### VOX gain and delay adjustment

- ① Attach the connector of the VS-1SC into the multi-connector on the transceiver and tighten the screw.
  - Toggle the VOX/PTT select switch to [VOX].
- ② Enter user set mode. (p. 16)
- ③ Push [P0] several times to select the “VOX Gain” or “VOX Delay” items. Then, push [Side2] or [Side3] to set the desired level/condition.
- ④ Rotate [VOL] to turn the power OFF to exit user set mode.

#### • VOX Gain

The VOX sensitivity level can be adjusted from OFF or 1 to 6 (more sensitive).

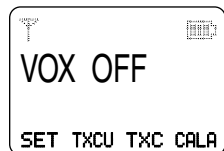

VOX function is OFF

[Side2]  
Push  
[Side3]

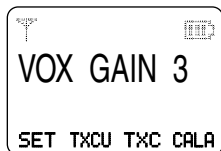

VOX gain level 3  
(default)

#### • VOX Delay

The VOX delay time can be set from 0.5 to 3.0 sec. (0.5 sec. step) for a convenient interval before returning to receive.

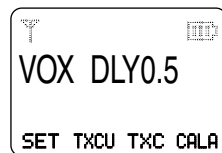

0.5 sec (min.)  
(default)

[Side2]  
Push  
[Side3]

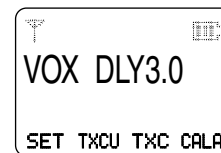

3.0 sec (max.)

**NOTE:** MIC/VOX gain can be adjusted via the Adjusting pot using a thin screw driver.



Your Icom radio generates RF electromagnetic energy during transmit mode. This radio is designed for and classified as “Occupational Use Only”, meaning it must be used only during the course of employment by individuals aware of the hazards, and the ways to minimize such hazards. This radio is NOT intended for use by the “General Population” in an uncontrolled environment.

This radio has been tested and complies with the FCC and IC RF exposure limits for “Occupational Use Only”. In addition, your Icom radio complies with the following Standards and Guidelines with regard to RF energy and electromagnetic energy levels and evaluation of such levels for exposure to humans:

- FCC OET Bulletin 65 Edition 97-01 Supplement C, Evaluating Compliance with FCC Guidelines for Human Exposure to Radio Frequency Electromagnetic Fields.
- American National Standards Institute (C95.1-1992), IEEE Standard for Safety Levels with Respect to Human Exposure to Radio Frequency Electromagnetic Fields, 3 kHz to 300 GHz.
- American National Standards Institute (C95.3-1992), IEEE Recommended Practice for the Measurement of Potentially Hazardous Electromagnetic Fields— RF and Microwave.
- The following accessories are authorized for use with this product. Use of accessories other than those specified may result in RF exposure levels exceeding the FCC and IC requirements for wireless RF exposure; Belt Clip (MB-93, MB-94, MB-96N and MB-96F), Rechargeable Li-ion Battery Pack (BP-232FM) and Speaker-microphone (HM-169IS).



To ensure that your exposure to RF electromagnetic energy is within the FCC and IC allowable limits for occupational use, always adhere to the following guidelines:

- **DO NOT** operate the radio without a proper antenna attached, as this may damage the radio and may also cause you to exceed FCC and IC RF exposure limits. A proper antenna is the antenna supplied with this radio by the manufacturer or antenna specifically authorized by the manufacturer for use with this radio.
- **DO NOT** transmit for more than 50% of total radio use time (“50% duty cycle”). Transmitting more than 50% of the time can cause FCC and IC RF exposure compliance requirements to be exceeded. The radio is transmitting when the TX indicator lights red. You can cause the radio to transmit by pressing the “PTT” switch.
- **ALWAYS keep** the antenna at least 2.5 cm (1 inch) away from the body when transmitting and only use the Icom belt-clips listed on page 27 when attaching the radio to your belt, etc., to ensure FCC and IC RF exposure compliance requirements are not exceeded. To provide the recipients of your transmission the best sound quality, hold the antenna at least 5 cm (2 inches) from your mouth, and slightly off to one side.

The information listed above provides the user with the information needed to make him or her aware of RF exposure, and what to do to assure that this radio operates within the FCC and IC RF exposure limits of this radio.

## 8 SAFETY TRAINING INFORMATION

### Electromagnetic Interference/Compatibility

During transmissions, your Icom radio generates RF energy that can possibly cause interference with other devices or systems. To avoid such interference, turn off the radio in areas where signs are posted to do so. **DO NOT** operate the transmitter in areas that are sensitive to electromagnetic radiation such as hospitals, aircraft, and blasting sites.

### Occupational/Controlled Use

The radio transmitter is used in situations in which persons are exposed as consequence of their employment provided those persons are fully aware of the potential for exposure and can exercise control over their exposure.



Votre radio Icom produit une énergie électromagnétique de radiofréquences (RF), en mode de transmission. Cette radio est conçue pour un «usage professionnel seulement» et classée comme tel, ce qui signifie qu'elle doit être utilisée uniquement dans le cadre d'un travail par des personnes conscientes des dangers et des mesures visant à minimiser ces dangers. Elle N'EST PAS conçue pour une «utilisation grand public», dans un environnement non contrôlé.

Cet appareil a été évalué et jugé conforme, aux limites d'exposition aux RF de la FCC et d'IC, pour une «utilisation grand public». En outre, votre radio Icom satisfait les normes et directives qui suivent en matière de niveaux d'énergie et d'énergie électromagnétique de RF et d'évaluation de tels niveaux en ce qui concerne l'exposition humaine:

- Supplément C, édition 97-01, du Bulletin OET n° 65 de la FCC, «Evaluating Compliance with FCC Guidelines for Human Exposure to Radio Frequency Electromagnetic Fields».
- Norme de l'American National Standards Institute (ANSI): IEEE C95.1-1992 sur les niveaux de sécurité compatibles avec l'exposition humaine aux champs électromagnétiques de radiofréquences (3 kHz à 300 GHz).
- Norme de l'ANSI: IEEE C95.3-1992 sur la méthode d'évaluation recommandée du champ magnétique potentiellement dangereux des radiofréquences et des micro-ondes.
- Les accessoires illustrés à la p. 27–28 sont approuvés pour une utilisation avec ce produit. L'utilisation d'accessoires autres que ceux précisés peut entraîner des niveaux d'exposition aux RF supérieures aux limites établies par la FCC et d'IC en matière d'exposition aux RF sans fil.



MISE EN GARDE

**Afin de vous assurer que votre exposition à une énergie électromagnétique de RF se situe dans les limites permises par la FCC et d'IC pour une utilisation grand public, veuillez en tout temps respecter les directives suivantes:**

- **NE PAS** faire fonctionner la radio sans qu'une antenne appropriée y soit fixée, car ceci risque d'endommager la radio et causer une exposition supérieure aux limites établies par la FCC et d'IC. L'antenne appropriée est celle qui est fournie avec cette radio par le fabricant ou une antenne spécialement autorisée par le fabricant pour être utilisée avec cette radio.
- **NE PAS** émettre pendant plus de 50 % du temps total d'utilisation de l'appareil («50 % du facteur d'utilisation»). La notion «50% du facteur d'utilisation» s'applique également au mode VOX/PTT. Émettre pendant plus de 50 % du temps total d'utilisation peut causer une exposition aux RF supérieure aux limites établies par la FCC et d'IC. Lorsque le voyant DEL rouge s'allume, cette radio est en train d'émettre. La radio émettra si vous appuyez sur le bouton du microphone.
- **TOUJOURS tenir** l'antenne éloignée d'au moins 2,5 cm de votre corps au moment d'émettre et utiliser uniquement l'attache pour ceinture Icom illustrée à la p. 27, lorsque vous attachez la radio à votre ceinture, ou à autre chose, de façon à vous assurer de ne pas provoquer une exposition aux RF supérieure aux limites fixées par la FCC et d'IC. Pour offrir à vos interlocuteurs la meilleure qualité de transmission possible, tenez l'antenne à au moins 5 cm de votre bouche et légèrement de côté.

Les renseignements ci-dessus fournissent à l'utilisateur toute l'information nécessaire sur l'exposition aux RF et sur ce qu'il faut faire pour assurer que cette radio fonctionne en respectant les limites d'exposition aux RF établies par la FCC et d'IC.

#### **Interférence électromagnétique et compatibilité**

En mode de transmission, votre radio Icom produit de l'énergie de RF qui peut provoquer des interférences avec d'autres appareils ou systèmes. Pour éviter de telles interférences, mettez la radio hors tension dans les secteurs où une signalisation l'exige. **NE PAS** faire fonctionner l'émetteur dans des secteurs sensibles au rayonnement électromagnétique tels que les hôpitaux, les aéroports et les sites de dynamitage.

#### **Usage professionnel/contrôlé**

Ce radio émetteur est utilisé dans des cas où des personnes sont exposées en raison de leur travail, pourvu qu'elles soient conscientes du risque d'exposition et qu'elles puissent exercer un contrôle sur cette exposition.





**Count on us!**

A-6831H-1EX-③  
Printed in Japan  
© 2010–2015 Icom Inc.

Printed on recycled paper with soy ink.

**Icom Inc.**

1-1-32 Kamiminami, Hirano-ku, Osaka 547-0003, Japan