

Hytera™

OWNER'S MANUAL

DMR MOBILE RADIO

Hytera **HYT**

is the trademark of Hytera Communications Corp., Ltd.
© 2010 Hytera Corp., Ltd. All Rights Reserved.

Address: HYT Tower, Hi-Tech Industrial Park North, Beihuan
RD., Nanshan District, Shenzhen, China
Postcode: 518057
<http://www.hytera.cn>



Hytera **HYT**

© 2010 Hytera Corp., Ltd

D03207 X05031



The Hytera logo is displayed in a light gray, sans-serif font on a dark gray rectangular background.

Preface

Thank you for purchasing Hytera DMR Digital Mobile Radio. As a product built to the DMR standard, It is endowed with ergonomic design, all-round digital functions and remarkable quality to increase your management efficiency and enable you to be responsive to emergent situations.

To derive optimum performance from your product, please read this manual and the supplied Safety Information Booklet carefully before use.

The manual is applicable to the following model:

MD78X

MD78XG

Instructional Icons

The following icons are available through this manual:

Alert Icons



Caution: indicates situations that could cause damage to your product.



Note: indicates tips that can help you make better use of your product.

Function Icons



: indicates functions that are available on digital channel only.



: indicates functions that are available on analog channel only.

Functions marked with no function icons are available on both analog and digital channels.

Term Explanation

Key Operation

Short press: to press a key and release it quickly.

Long press: to press a key and remain holding it down for a pre-defined period (2 seconds by default).

Hold down: to press a key and remain holding it down.

Private Call

Private Call is a call initiated by a single user to another user.

Group Call

Group Call is a call initiated by a single user to a group.

All Call

All Call is a call initiated by a single user to all the other users on a channel.

Squelch

This technology can remove excessive background noises, improving your communication quality.

PTT ID

PTT ID, namely radio identity, allows a radio with display or the control center to identify the calling party.

Copyright Information

Hytera and HYT are trademarks or registered trademarks of Hytera Communications Co., Ltd. (“Hytera”) in PRC and/or other countries or areas. Hytera retains the ownership of its trademarks and product names. All other trademarks and/or product names that may be used in this manual are properties of their respective owners.

The Hytera product described in this manual may include Hytera computer programs stored in memory or other media. Laws in PRC and/or other countries or areas protect the exclusive rights of Hytera with respect to its computer programs. The purchase of this product shall not be deemed to grant, either directly or by implication, any rights to the purchaser with respect to Hytera computer programs. Any Hytera computer programs may not be copied, modified, distributed, decompiled, or reverse-engineered in any manner without the prior written consent of Hytera.

The AMBE+2™ voice coding technology embodied in this product is protected by intellectual property rights including patent rights, copyrights and trade secrets of Digital Voice Systems, Inc.

This voice coding technology is licensed solely for use within this product. The user of this technology is explicitly prohibited from attempting to decompile, reverse engineer, or disassemble the Object Code or in any other way convert the Object Code into a human readable form.

U.S. Patent Nos. #6,912,495 B2, #6,199,037 B1, #5,870,405, #5,826,222, #5,754,974, #5,701,390, #5,715,365, #5,649,050, #5,630,011, #5,581,656, #5,517,511, #5,491,772, #5,247,579, #5,226,084 and #5,195,166.

Disclaimer

Hytera endeavors to achieve the accuracy and completeness of this manual, but no warranty of accuracy or reliability is given. All the specifications and designs are subject to change without prior notice due to continuous technology development. No part of this manual may be copied, modified, translated, or distributed in any manner without the express written permission of Hytera.

If you have any suggestions or would like to learn more details, please visit our website at:<http://www.hytera.cn>.

RF Radiation Information

RF Radiation Profile

Radio Frequency (RF) is a frequency of electromagnetic radiation in the range at which radio signals are transmitted. RF technology is widely used in communication, medicine, food processing and other fields. It may generate radiation during use.

RF Radiation Safety

In order to ensure user health, experts from relevant industries including science, engineering, medicine and health work with international organizations to develop standards for safe exposure to RF radiation. These standards consist of:

- United States Federal Communications Commission, Code of Federal Regulations; 47CFR part 2 sub-part J;
- American National Standards Institute (ANSI)/Institute of Electrical and Electronic Engineers (IEEE) C95. 1-1992;
- Institute of Electrical and Electronic Engineers (IEEE) C95. 1 – 1999;
- International Commission on Non-Ionizing Radiation Protection (ICNIRP) 1998.

FCC Regulations

Federal Communication Commission (FCC) requires that all radio communication products should meet the requirements set forth in the above standards before they can be marketed in the U.S, and the manufacturer shall post a RF label on the product to inform users of operational instructions, so as to enhance their

occupational health against exposure to RF energy.

As a conscientious company centering on users, Hytera strictly complies with the foregoing requirements from design, production and test.

EU Regulatory Conformance

As certified by the qualified laboratory, the product is in compliance with the essential requirements and other relevant provisions of the Directive 1999/5/EC. Please note that the above information is applicable to EU countries only.

CE 0678 ①

Contents

Checking Items in the Package	2	Call Logs	13
Product Overview	3	Scan	14
Front Panel	3	Zone	14
Rear Panel	3	Settings	14
Programmable Keys	4	Accessories	16
Installation	5	Functions and Operations	17
Instructions	5	Home Screen	17
Installation Tools	5	Scan	17
Installation Steps	6	Public Address	17
Status Indication	7	Talk Around	18
LCD Icon	7	Monitor	18
LED Indicator	8	Squelch Off	18
Basic Operations	9	Emergency	18
Turning the Radio On/Off	9	Ignition Sense	21
Adjusting the Volume	9	Scrambler /Encrypt	22
Selecting a Zone	9	Busy Channel Lockout	22
Selecting a Channel	9	Time-out Timer (TOT)	22
Switching the Channel Mode	9	Pseudo Trunking	22
Call	10	MIC AGC	23
Private Call	10	Emergency Footswitch	23
Group Call	10	Channel Steering	23
All Call	11	Signaling Introduction	24
Calls on Analog Channels	11	HDC1200	24
Menu Navigation	12	Troubleshooting	25
Contact	12	Care and Cleaning	26
Message	12	Optional Accessories	27
		Appendix	28
		Input Method	28

Checking Items in the Package

Please unpack carefully and check that all items listed below are received. If any item is missing or damaged, please contact your dealer.

1 Radio Unit

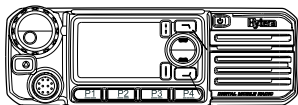

2 Palm Microphone

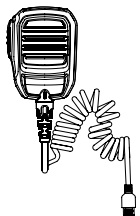

3 Microphone Hanger and Screws

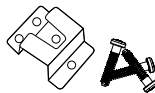

4 Power Cord

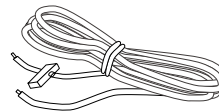

5 Fuse



6 Mounting Bracket Kit

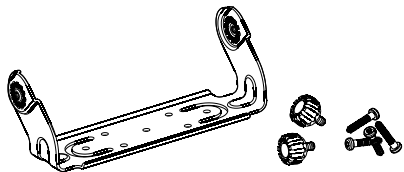

7 GPS Antenna

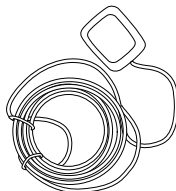

8 Owner's Manual /Quick Reference Guide/Safety Information Booklet

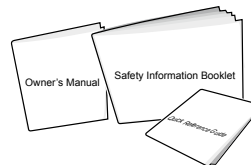

Note: To realize functions enabled by inputting, please purchase a palm microphone with keypad. Go to Optional Accessories for more details.

Product Overview

Front Panel

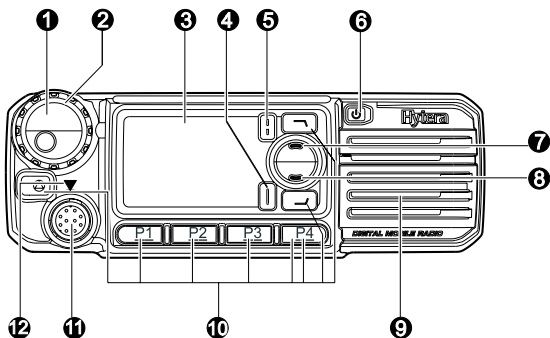



No.	Part Name	No.	Part Name
1	Volume Control / Channel Selector Knob	2	LED Indicator
3	LCD Display	4	OK/Menu Key
5	Back Key	6	Power On/Off Key
7	Up Key	8	Down Key
9	Speaker	10	Programmable Keys
11	Microphone Jack	12	Microphone Installation Index

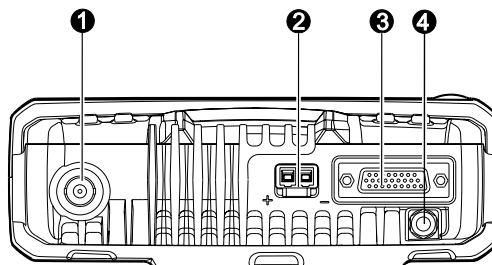





Rear Panel





No.	Part Name	No.	Part Name
1	RF Antenna Connector	2	Power Inlet
3	Accessory Jack	4	GPS Antenna Connector

Programmable Keys

For enhanced convenience, you may request your dealer to program the keys **P1**, **P2**, **P3**, **P4**, ,  and  as shortcuts to the functions listed below:

No.	Shortcut Keys	Description
1	Zone Up	To select a desired zone quickly
2	Zone Down	
3	Contact List 	To access the menu "Contact List" quickly
4	Message 	To access the menu "Message" quickly
5	Call Log 	To access the menu "Call Logs" quickly
6	Adjust Power Level	To adjust power level quickly
7	Public Address	To make public address via the external speaker quickly
8	Talk Around	To directly communicate with other radios
9	Monitor 	To adjust the condition for incoming signal match
10	Monitor Momentary 	
11	Squelch Off 	To always unmute speaker no matter whether carrier is present or not
12	Squelch Off Momentary 	
13	Home Screen	To quickly return to the previous menu or home screen

14	Scan	To receive signals on other channels
15	Nuisance Temporary Delete	To temporarily ignore unwanted channel activity
16	Emergency	To summon help in emergent situations
17	Adjust Squelch Level 	To temporarily adjust the squelch threshold required for the radio to unmute
18	Scrambler  /Encrypt 	Scrambler: To encrypt your voice so as to guarantee privacy of your communication Encrypt: To encrypt your voice and message so as to guarantee privacy of your communication



Note:

- 1 Long and short press of a key can be assigned with different functions by your dealer.
- 2  is programmed as the **Emergency** key by default, and is programmable by your dealer.

Installation

Before you install the radio in a vehicle, be sure to read the following instructions carefully:

Instructions

- The radio operates with cathode-grounded power supply of $13.6V \pm 15\%$ only. Please check polarity and voltage of the power supply on the vehicle before you install the radio.
- Please check how long the screws will extend from the bottom surface of the radio, before you install the radio. Drill the mounting hole cautiously to avoid damage to the vehicle wiring and other parts.
- Please connect Hytera supplied antenna and power cord to the radio, before you install it in the bracket. And make sure the antenna and power cord is dedicated for Hytera digital radios.
- Install the radio with Hytera supplied mounting bracket, to avoid radio looseness in case of accidents. The loose radio may cause bodily injury.
- Install the radio in a location where it's easy to reach the front panel controls.
- Please make sure there's sufficient space at back of the radio for wiring.
- When the fuse for DC power cord needs replacement, it must be replaced by a fuse with the same specification.

Installation Tools

- Electric drill
- Cross head screwdriver

- Hex socket sleeve (used for 4.8*20mm self-tapping screws)

Installation

Installation Steps

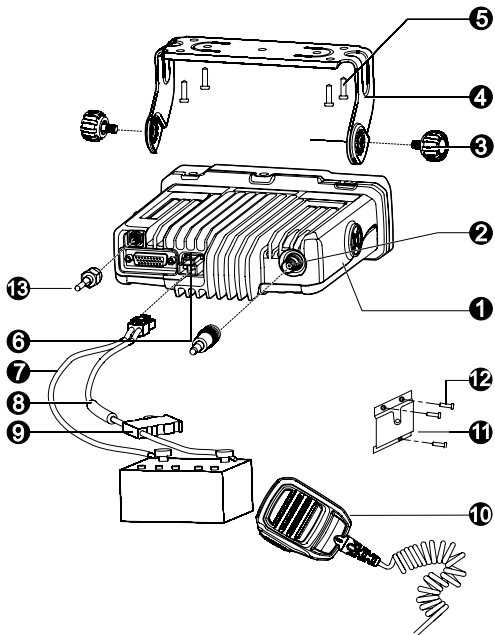

A Install the **bracket** in a location where it's easy to operate the radio.

B Connect accessories such as **antenna** and **power cord** to the radio.

C Slide the **radio** into the mounting bracket and secure it using the locking knobs.

D Install the **microphone hanger** in a location where it can be reached easily.

E Plug the **palm microphone** into the microphone jack on the front panel (but at first align the triangle index on the palm microphone with the microphone installation index), and place it on the hanger when you do not use it.

No.	Part Name
1	Radio Unit
2	RF Antenna Connector
3	Locking Knobs
4	Mounting Bracket
5	4.8 * 20 mm Self-tapping Screws
6	Power Inlet
7	Black Power Cord
8	Red Power Cord
9	Fuse
10	Palm Microphone
11	Microphone Hanger
12	4 * 16 mm Self-tapping Screws
13	GPS Antenna Connector

Status Indication

LCD Icon

■ Status Icon

Icon Name	Icon	Radio Status
RSSI		No signal
		More bars indicate better signal strength
Message Icon		New message/unread message
		InBox is full
Scan Icon		Scanning is in progress
		Scanning pauses on a non-priority channel
		Scanning pauses on Priority Channel 1
		Scanning pauses on Priority Channel 2
TX Power Icon		Low TX power for the current channel
		High TX power for the current channel
Monitor Icon		The Monitor feature is active
Speaker Icon		The speaker is unmuted

Emergency Icon		The Emergency mode (other than secret emergency) is active or an emergency message is received
Knob Operation Mode Icon		The knob currently operates in channel selection mode
		The knob currently operates in volume adjustment mode
GPS Icon		The GPS feature is active, and valid GPS data is received
		The GPS feature is active, but no valid GPS data is received
Scrambler/Encrypt Icon		The Scrambler/Encrypt feature is active



Note: The description related to the GPS feature in this manual is applicable to MD78XG only.

Status Indication

■ Operation Mode Icon

Icon Name	Icon	Operation Mode
Operation Mode Icon	DM	Direct Mode: Under this mode, radios communicate with each other directly
	RM	Repeater Mode: Under this mode, radios communicate with each other via a repeater

LED Indicator

The LED indicator will help you easily identify the current radio status.

LED Indicator	Radio Status
LED flashes green.	Powering on
LED glows red.	Transmitting
LED glows green.	Receiving
LED flashes green slowly.	Scanning
LED flashes orange rapidly.	Emergency
LED glows orange.	Call ended (within the preset time period)

Basic Operations

Turning the Radio On/Off

To turn the radio on, long press the **Power On/Off** key until the radio shows power-up screen and sounds power-up alert, and the LED flashes green. To turn the radio off, press the **Power On/Off** key.

Adjusting the Volume

When the **Volume Control / Channel Selector** knob operates in volume adjustment mode (the radio displays the icon ), rotate the knob clockwise to increase the call volume, or counter-clockwise to decrease it.

Selecting a Zone

A zone is a group of channels exhibiting the same property, and is programmed by your dealer. The radio supports up to 64 zones, each with a maximum of 16 channels. You may select a zone through any of the following methods:

1. Through menu selection
Go to the menu "Zone", and use the **Up/Down** key to select your desired zone.
2. Through the function keys
You may quickly toggle to your desired zone by pressing the programmed **Zone Up** or **Zone Down** key.



Note: Your dealer may designate the power-up zone and channel. If not, the radio will enter the zone and channel last used.

Selecting a Channel

Press the **Volume Control / Channel Selector** knob to switch it to channel selection mode (the radio displays the icon ) and then rotate the knob to select your desired channel. Alias of the current channel will appear in the home screen.



Note: The knob is in volume adjustment mode by default, and will return to this mode in 5 seconds after you select a channel.

Switching the Channel Mode

Each channel can be programmed as either analog channel or digital channel. If the current zone includes both analog and digital channels, you may quickly switch between digital and analog channels through the **Volume Control / Channel Selector** knob.

Call

To ensure optimal volume of the receiving radio, hold the palm microphone approximately 2.5 to 5 centimeters away from your mouth.

Private Call

Transmitting a Private Call

You may transmit a Private Call through any of the following methods. When transmitting a Private Call, the icon  will appear.

- Transmitting a call to the preset contact
In the home screen, hold down the **PTT** key on the palm microphone to transmit a Private Call to the Private Call contact preset for the current channel.



Note: Your dealer may preset a contact for each digital channel. The preset contact could be a Private Call contact, a Group Call contact or an All Call contact.

- Transmitting a call through Contact List or Call Logs
 - 1 Go to "Contact -> Contact List", or go to "Call Logs" and access the Outgoing/Incoming/Missed list.
 - 2 Use the **Up/Down** key to select the Private Call contact you want to call.
 - 3 Hold down the **PTT** key to transmit the Private Call.
- Transmitting a call through Manual Dial
 - 1 Go to "Contact -> Manual Dial".
 - 2 Input a Private Call number you want to call using the

microphone with a keypad.

- 3 Hold down the **PTT** key to transmit the Private Call.

Receiving and Responding to a Private Call

When a Private Call is received, your radio will display the icon



You may hold down the **PTT** key within the preset time period to call back. If you do not respond to a received Private Call, your radio will display the missed call icon

Group Call

Transmitting a Group Call

You may transmit a Group Call through any of the following methods. When transmitting a Group Call, the icon  will appear.

- Transmitting a call to the preset contact
In the home screen, hold down the **PTT** key to transmit a Group Call to the Group Call contact preset for the current channel.
- Transmitting a call through Contact List
 - 1 Go to "Contact -> Contact List".
 - 2 Use the **Up/Down** key to select the Group Call contact you want to call.
 - 3 Hold down the **PTT** key to transmit the Group Call.

Call

Receiving and Responding to a Group Call

When a Group Call is received, your radio will display the icon



You may hold down the **PTT** key within the preset time period to call back.

All Call

Transmitting an All Call

Methods are the same as those in *Transmitting a Group Call*.

When transmitting an All Call, the icon  will appear.



Note: You can transmit an All Call only when it is enabled by your dealer.

Receiving an All Call

When an All Call is received, your radio will display the icon .



Note: You cannot respond to an All Call.

Calls on Analog Channels

To transmit on an analog channel, hold down the **PTT** key and speak into the microphone. To receive, release the **PTT** key.

Menu Navigation

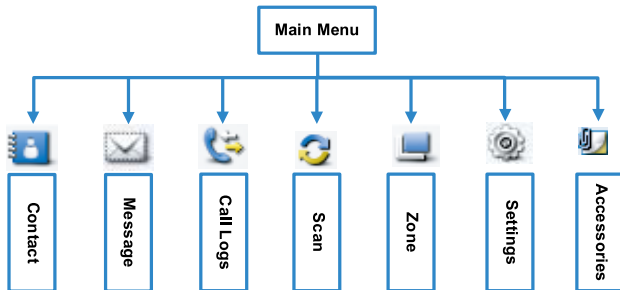

Contact

To access this item, press the **Menu** key in the home screen and then select "Contact".

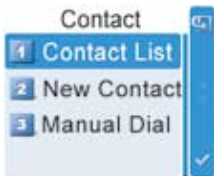

Contact List

You can save up to 200 entries in the list. To access this item, select "Contact -> Contact List" or press the shortcut key for Contact List.

Editing a Contact

You can edit the number and alias of each Private Call contact.

Viewing a Contact

You can view details of each contact.

Deleting a Contact

You can delete a Private Call contact. However, please note that you can not delete the contact when there is only one entry left in the list. In addition, the Private Call contact preset on the currently used channel cannot be deleted.

New Contact

You can add a Private Call contact to the contact list. The number and alias of each contact must be unique, and the available number range is 1-16776415.

Manual Dial

You can manually input the Private Call number for calling.

Message

To access this item, press the **Menu** key in the home screen and then select "Message", or press the shortcut key for Message directly.



Menu Navigation

New Msg

You can create new text message (256 characters at most) and send it to an individual user or to a talk group.

Quick Text

Under this option there are some text messages (10 entries at most) preset by your dealer. You can choose to edit and send any entry.

InBox

The InBox can save up to 20 received messages. When the InBox is full, the icon  will appear, and the earliest message will be overwritten by the latest one automatically.

For each message, you can choose to perform any of these operations: Reply, Forward, View Details and Delete.

To delete all messages in the InBox, select "Message -> InBox -> Delete All".

OutBox

The OutBox can save up to 20 sent messages. When the OutBox is full, the earliest message will be overwritten by the latest one automatically.

For each message, you can choose to perform any of these operations: Resend, Forward, View Details and Delete.

To delete all messages in the OutBox, select "Message -> OutBox -> Delete All".

Drafts

The Drafts can save up to 20 draft messages. When the Drafts

is full, the earliest message will be overwritten by the latest one automatically.

For each message, you can choose to perform any of these operations: Send, Save and Delete.

To delete all messages in the Drafts, select "Message -> Drafts -> Delete All".

Call Logs

To access this item, press the **Menu** key in the home screen and then select "Call Logs", or press the shortcut key for Call Logs directly.



This radio can save up to 10 private call entries in the Outgoing/Incoming/Missed list respectively. When the Outgoing/Incoming/Missed list is full, the earliest entry will be overwritten by latest one automatically.

After accessing a list and selecting an entry, you can perform any of these operations: hold down the **PTT** key to initiate a call; add it to Contact List; or delete it.

To delete all entries in the Outgoing/Incoming/Missed list at a time, select "Call Logs -> Outgoing/Incoming/Missed -> Delete All".

Menu Navigation

Scan

To access this item, press the **Menu** key in the home screen and then select "Scan".



Scan On/Off

The Scan feature allows you to listen to communication activities on other channels so that you can keep a close track of your team members. This option is used to enable or disable the function.

Scan List

You can request your dealer to create a scan list for each channel. Each list may contain 32 channels at most (either digital channel or analog channel is OK). After accessing the list, you can perform any of the following operations:

Adding a Channel

To include a new channel into the active scan list.

Editing Priority Channel

To set the selected channel as a non-priority or as a priority channel. If you are interested in activities on a channel, you can set it as a priority channel, which will be scanned more frequently than a non-priority channel.

Each scan list may contain two priority channels at most. **P1** indicates priority channel 1, and **P2** indicates priority channel 2.

Deleting a Channel

To remove a channel from the active scan list. However, the first channel in the list can not be deleted.

Zone

To access this item, press the **Menu** key in the home screen and then select "Zone".

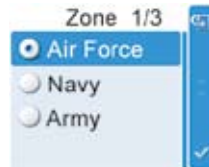

This radio supports up to 64 zones. You can use this menu to select your desired zone.

Settings

To access this item, press the **Menu** key in the home screen and then select "Settings".





Radio Set

You can optimize your radio performance by customizing related parameters according to actual needs and your preferences.

Power Level

This option allows you to set TX power level. Alternatively, you can change the power level by pressing the shortcut key for Adjust Power Level in the home screen.

There are two levels available: High (indicated by ) and Low (indicated by ). High power level enables you to communicate with farther team members.



Note: Power level should be set for each channel individually.

Squelch

This option allows you to select an appropriate squelch level. Alternatively, you can change the squelch level by pressing the shortcut key for Adjust Squelch Level in the home screen. There are three levels available: Tight, Normal and Open. The default squelch level is “Normal”, and is often used in low noise environment.

And generally, “Tight” is used in high noise environment. It requires stronger signal for the radio to unmute. However, if the squelch level is set to Open, the speaker will keep unmuted irrespective of the decoding conditions.

Scrambler /Encrypt

To set whether to enable the Scrambler/Encrypt feature.

Language

To set the language in which all interface information is displayed.

Backlight

To set the backlight parameters. There are three options available: On, Off and Timer. The timer is programmed by your dealer, with an available duration of 5-60 seconds.

Brightness

To set the display brightness. You can raise or lower it using the **Up/Down** key.

LED

To set whether to enable LED indication.

Tone

To set alert tones for your radio. You can set the following tones: Radio Silent: to set whether the radio will give tone indication. If Silent On is selected, all tone indication will be cancelled.

Talk Permit: to set whether the radio will give tone indication for transmission. The following options are available: Disable (no tone indication for transmission), Digital Only (tone indication for transmission on digital channels only), Analog Only (tone indication for transmission on analog channels only), and Enable (tone indication for transmission on both analog and digital channels).

Private Ring: to set whether the radio will give tone indication when it receives a private call.

TextMsg Ring: to set whether the radio will give tone indication when it receives a message.

Keypad: to set whether the radio will give tone indication when you are making keypad operations.

Menu Navigation

Device Info

With this option, you can view basic information of your radio, including serial number, radio model, frequency range and firmware version, etc.

Accessories



To access this item, press the **Menu** key in the home screen and then select "Accessories".

GPS

Position

With this option, you can view longitude, latitude, time, date, speed, altitude and SA (satellite) information of your radio.

GPS Text Msg 

If the GPS feature is enabled via the programming software, you can send the GPS text message to your desired contact.

Operation:

1. Select "GPS Msg", and press the **OK** key to access the menu "Contact List".
2. Use the **Up/Down** key to select a desired contact.
3. Press the **OK** key to send the GPS message to the selected contact.

Time Zone

You can choose your time zone to correct the received GPS time. We recommend you to set the time zone before your initial use of this feature.

Functions and Operations

Home Screen

The feature allows you to quickly return to the previous menu or the home screen.

Operation:

In the editing screen, press the programmed **Home Screen** key, and the radio exits the screen and returns to the previous menu immediately; in other screens, press the key, and the radio returns to the home screen immediately.

Scan

This feature allows you to listen to communication activities on other channels so that you can keep a close track of your team members.

Operation:

1. To enable the feature, you can select "On" from the menu "Scan"; or
Press the programmed **Scan** key in the home screen; or
Switch to a channel on which the feature "Auto Scan" is enabled via the programming software.
2. After the feature is enabled, your radio will scan according to the scan list set for the channel on which scanning starts. The scanning process is as follows:
 - During scanning, the LCD displays the icon , and the LED flashes orange slowly.
 - When activities are detected on a channel, the radio will stay on the channel to receive current activities. If your radio stays

on a non-priority channel, the LCD will display icon ; if on Priority Channel 1 or Priority Channel 2, the LCD will display icon P_1 or icon P_2 respectively.

- If you don't want to hear activities on the channel, press the programmed **Nuisance Temporary Delete** key to remove the channel from the scan list temporarily.
 - If you want to continue staying on the channel, press the programmed **Monitor** or **Squelch Off** key during scan stay.

3. To exit the scanning process, you can select "Off" from the menu "Scan", or press the programmed **Scan** key again.

Public Address

This feature allows public address via the external speaker. After the feature is enabled, your voice will not be transmitted, but output via the external speaker (connected to the accessory jack on the rear panel) if you hold down the **PTT** key and speak.

Operation:

1. Press the programmed **Public Address** key to enable the feature.
2. Hold down the **PTT** key and speak into the microphone. Then your voice will be broadcasted clearly via the external speaker.
3. To disable the feature, press the **Public Address** key again.



Note: When this feature is enabled, you can neither communicate with other users, nor enter the menu.

Talk Around

You can continue to communicate in DM mode by pressing the programmed **Talk Around** key, when your repeater malfunctions, or when your radio is out of the repeater's range but within talking range of other radios.



Operation:

Press the programmed **Talk Around** key to switch between DM mode and RM mode.

Monitor

To adjust match conditions for signal receiving, you can enable the feature "Monitor".

Operation:

- Press the programmed **Monitor** key to enable the feature, and the radio displays icon . To disable the feature, press this key again.
- Hold down the programmed **Monitor Momentary** key to enable the feature, and the radio displays the icon . To disable the feature, release this key.

Squelch Off

If the feature "Squelch Off" is enabled, the speaker will keep unmuted no matter whether carrier is present.

Operation:

- Press the programmed **Squelch Off** key to enable the feature.
Then the radio displays the icon  and sounds background

noise. To disable the feature, press this key again.

- Hold down the programmed **Squelch Off Momentary** key to enable the feature. Then the radio displays the icon  and sounds background noise. To disable the feature, release this key.

Emergency

In case of an emergency, you can use the feature to ask for help from your companion or control center. The Emergency process has the highest priority. You can make emergency operation even when your radio is transmitting or receiving.

To enable the feature on a channel, an emergency system must be assigned to the channel via the programming software. In addition, the Emergency type, Emergency ID type and Emergency mode are settable via the programming software.

Emergency Type

For each Emergency mode, there are four Emergency types available. You can select one of them via your dealer:

Functions and Operations

Emergency Type	Description
Siren Only	In Emergency mode, the radio will sound shrill alarm tone and display icon  .
Regular	In Emergency mode, the radio will give audible and visible indication.
Silent	In Emergency mode, the radio won't give any audible or visible indication.
Silent with Voice	In Emergency mode, the radio won't give any audible or visible indication, but will receive voice ACK from the companion or control center automatically.

Emergency ID Type





Your radio supports two Emergency ID types. You can select one of them via your dealer:

Emergency ID Type	Description
None	No signaling is used when the radio sends alarm information.
HDC1200	HDC1200 signaling is used when the radio sends alarm information.

Emergency Mode

Your radio supports three Emergency modes. You can select one

of them via your dealer (Note: For the following operation methods, we take the "Regular" type as an example).

Emergency Mode	Description
Alarm 	In this mode, you can send alarm information to your companion or control center by pressing the programmed Emergency key, but you cannot talk with them.
Alarm with Call 	In this mode, you can send alarm information by pressing the programmed Emergency key. When the icon  appears, you can speak into the microphone, allowing your voice and background noise to be transmitted automatically (you do not need to hold down the PTT key).
Call Only	In this mode, press the programmed Emergency key to go to the Revert Channel. When the icon  or  appears, you can speak into the microphone, allowing your voice and background noise to be transmitted automatically (you do not need to hold down the PTT key).

Operation Methods for Analog Emergency

■ Alarm (None & HDC1200)





Operation: Press the programmed **Emergency** key to send alarm information. The radio displays the icon  and text information "Sending Alarm", with red LED glowing. (None: If "Local Emergency Alarm" is enabled via the programming software, an alarm tone will sound.)



Two methods are available for you to exit the Emergency mode:

1. Once the emergency cycles expire, the radio will exit the Emergency mode automatically.
2. Long press the programmed **Emergency** key.

■ Alarm with Call (None & HDC1200)

Operation:

1. Press the programmed **Emergency** key to send alarm information. The radio displays the icon  and text information "Sending Alarm", with red LED glowing. (None: If "Local Emergency Alarm" is enabled via the programming software, an alarm tone will sound.)
2. When the icon  appears, you can speak into the microphone to make an emergency call.
3. When the icon  appears, you can receive. And when a call is received, the icon  appears.
4. If the preset Voice Cycles expire, you can hold down the **PTT** key to make the emergency call again (the radio displays the





icon , with red LED glowing). After the emergency call is transmitted, release the **PTT** key to receive (the radio displays icon , with LED flashing orange rapidly). And when a call is received, the icon  appears. (HDC1200 only)

Two methods are available for you to exit the Emergency mode:



1. After the preset Alarm Cycles and Voice Cycles expire, the radio will exit the Emergency mode automatically. (None)
2. Long press the programmed **Emergency** key.

■ Call Only (HDC1200)

Operation:

1. Press the programmed **Emergency** key to go to the Revert Channel, and the radio displays the icon .
2. If the feature "Alarm with Call to Follow" is enabled, you can speak into the microphone to make an emergency call when the radio displays the icon .
3. When the icon  appears, you can receive. And when a call is received, the icon  appears.
4. If the preset Voice Cycles expire, you can hold down the **PTT** key to make the emergency call again (the radio displays the icon , with red LED glowing). After the emergency call is transmitted, release the **PTT** key to receive (the radio displays

Functions and Operations

the icon , with LED flashing orange rapidly). And when a call is received, the icon  appears.

To exit the Emergency mode, long press the programmed **Emergency** key.









Note: Your dealer may set the number of alarm cycles and alarm duration (None), number of polite retries and impolite retries (HDC1200), number of voice cycles, duration of each transmission and TX interval.

Operation Method for Digital Emergency

■ Call Only

Operation:

1. Press the programmed **Emergency** key to go to the Revert Channel, and the radio displays the icon .
2. If the feature "Alarm with Call to Follow" is enabled, you can speak into the microphone to make an emergency call when the radio displays the icon .
3. When the icon  appears, you can receive. And when a call is received, the icon  appears.
4. If the preset Voice Cycles expire, you can hold down the **PTT** key to make the emergency call again (the radio displays the

icon , with red LED glowing). After the emergency call is transmitted, release the **PTT** key to receive (the radio displays icon , with LED flashing orange rapidly). And when a call is received, the icon  appears.

To exit the Emergency mode, long press the programmed **Emergency** key.



Note: Your dealer may set the number of voice cycles, duration of each transmission and TX interval.

Ignition Sense

The following options are available via the vehicle ignition. You may ask your dealer to assign any one to your radio.

- **PTT Disable:** The **PTT** key is enabled or disabled by following the ignition sense.

Operation:

To enable the **PTT** key, start the engine; to disable the **PTT** key, stop the engine.

- **Ignition or Switch:** The radio powers on or off by following either the ignition sense or the **Power On/Off** key.

Operation:

To power on the radio, start the engine or long press the **Power On/Off** key; to power it off, stop the engine or press the **Power On/Off** key.

Functions and Operations

- **Ignition Only:** The radio powers on or off by following the ignition sense only. The **Power On/Off** key does not work.

Operation:

To turn on the radio, start the engine; to turn it off, stop the engine (The **Power On/Off** key does not work).

Scrambler /Encrypt

The Scrambler/Encrypt feature can encrypt your audio signals to prevent eavesdropping. Thus privacy of your communication is guaranteed.

This Encrypt feature can encrypt your audio signals and messages to prevent eavesdropping. Thus privacy of your communication is guaranteed.

Operation:

- On an analog channel, go to "Main Menu -> Settings -> Radio Set -> Scrambler" and select "Enable" or "Disable"; on a digital channel, go to "Main Menu -> Settings -> Radio Set -> Encrypt" and select "Enable" or "Disable".
- Press the programmed **Scrambler/Encrypt** key to enable Scrambler or Encrypt on the current channel (a high-pitched tone sounds); press the key again to disable the feature (a low-pitched tone sounds).
- If the Scrambler/Encrypt feature is enabled for a channel via the programming software, switch to the channel to enable the feature, or exit the channel to disable the feature.

Busy Channel Lockout

If enabled via the programming software, this feature can prevent your radio interfering with other transmitting terminals on the same channel. If you hold down the **PTT** key while the channel is in use, your radio will keep beeping and display text information "Channel Busy!", alerting you to transmission prohibition. To stop beeping, please release the **PTT** key. When the channel is free, you can press and hold down the **PTT** key to transmit.

Time-out Timer (TOT)

The purpose of TOT is to prevent any user from occupying a channel for an extended period. If the preset time expires, the radio will automatically terminate transmission and keep beeping. To stop beeping, please release the **PTT** key. You must wait for a certain time period (preset by your dealer) to initiate another transmission.

If the pre-alert function is set by your dealer, your radio will alert you to the TOT expiration in advance.



Note: This feature is null in Emergency mode.

Pseudo Trunking

If your radio operates on a channel with this feature enabled and one time slot is already occupied, it can transmit and receive on the other free time slot, allowing you to communicate timely under emergent situations.

Functions and Operations

MIC AGC

If enabled via the programming software, your radio will process the audio signals during transmission, providing improved audio for the receiving radio.

Emergency Footswitch

This feature must be realized through further development. After successfully developed, you should request your dealer to enable it via programming software. This feature is quite useful in emergent situations to avoid any unexpected loss.



Note: Emergency footswitch will be unavailable if the Emergency feature is not enabled on the current channel.

Channel Steering

This feature must be realized through further development. After successfully developed, you should request your dealer to enable it via programming software. You can switch channels accurately and quickly with this feature.



Note: If this feature is enabled, you cannot switch channels via front panel operation.

Signaling Introduction

The radio supports the following signaling. You can ask your dealer to make appropriate settings on your radio. For detailed information, please contact your dealer.



HDC1200

The HDC1200 signaling is compatible with the MDC1200 signaling, and realizes functions such as PTT ID (Encoding & Decoding), Emergency (Encoding & Decoding) and Selective Call (Encoding & Decoding).

Encoding:

1. Hold down the **PTT** key during normal voice communication to send PTT ID.
2. Go to the menu "Contact List" and select a required contact. Then hold down the **PTT** key to send a selective call (Private Call/Group Call/All Call).

For encoding, the radio will provide the following indications:

- PTT ID/Selective Call: Your dealer can program whether the radio sounds side tone during encoding or sounds beeps after encoding.
- Selective Call: During encoding, the LED glows red, and the LCD displays the appropriate call icon (Private Call: ; Group Call: ; All Call: ). After encoding, the LED glows orange.

Decoding:



For decoding, the radio provides the following indications:

- PTT ID: After decoding, the LCD displays the icon  and ID or alias of the transmitting party.
- Selective Call: After decoding, the radio provides the following indications:

Alert:The radio will sound default alert.

LED:The LED glows green.

LCD:If your dealer enables the feature "Display Decode ID", the radio will display the appropriate call icon (Private Call: ;

Group Call: ; All Call: ) and alias of the transmitting party (ID of the transmitting party will be displayed if it is not in the contact list). If your dealer does not enable the feature "Display Decode ID", the radio will display the appropriate call icon only.

Troubleshooting

Phenomena	Analysis	Solution
The radio can not be powered on.	The power cord may be unconnected.	Connect the power cord correctly.
During receiving signals, the voice is weak, discontinuous or totally inactive.	The volume may be set to a low level.	Increase the volume by rotating the Volume Control knob clockwise.
	The antenna may get loose or may be improperly installed.	Power off the radio, re-install the antenna and power on the radio again.
You can not communicate with other members in Analog mode.	The speaker may be blocked or damaged.	Clean surface of the speaker. If the problem can not be solved, contact your dealer or our authorized service center for inspection and repair.
	The frequency or signaling may be inconsistent with that of other members.	Set your TX/RX frequency and signaling to the same as that of other members.
You can not communicate with other members in Digital mode although there is receiving indication.	You may be too far away from the group members.	Move towards other members. And make sure that you are within the communication range.
	Your ID may be inconsistent with that of other members. Consequently, the digital carrier can be received but can not be demodulated.	Set your ID to the same as that of other members.
Irrelevant communications or noises are heard on the analog channel.	You may be interrupted by radios using the same frequency.	Adjust the squelch level.
	The radio may be set with no signaling.	Set your radio with signaling to avoid interference at the same frequency, and make sure that all members share the same signaling.
The noise is too loud.	You may be too far away from other members.	Move towards other members, and then try again.
	You may be at an unfavorable position. For example, your communication may be blocked by high buildings or frustrated in the underground areas.	Move to an open and flat area, and try again.
	You may suffer from external disturbance (such as electromagnetic interference).	Stay away from equipment that may cause interference.
You can not use the keys.	The keypad may fail to function temporarily.	Restart the radio.
There is no display.	The LCD may fail to function temporarily.	Restart the radio.
The GPS cannot locate your position.	The GPS antenna is improperly connected.	Connect the GPS antenna correctly.
	No GPS signal is received.	Move to an open and flat area, and restart the radio.

If the above solutions can not fix your problems, or you may have some other queries, please contact us or your local dealer for more technical support.

Care and Cleaning

To guarantee optimal performance as well as a long service life of the product, please follow the tips below.

Product Care

- Keep the product at a place with good ventilation and heat dissipation to facilitate normal work.
- Do not place irrelevant articles on top of the product to ensure optimal heat dissipation.
- Do not place the product in corrosive agents, solutions or water.

Product Cleaning

- Clean up the dust and fine particles on the product parts with a clean and dry lint-free cloth or a brush regularly.
- Use a non-woven fabric with neutral cleanser to clean the keys, control knobs, LCD and jacks after long-time use. Do not use chemical preparations such as stain removers, alcohol, sprays or oil preparations. Make sure the product is completely dry before use.



Caution: Power off the product before cleaning.

Optional Accessories

The following items are the main optional accessories for the product, and please consult your local dealer for more information.

Desktop Microphone SM10A1



External Speaker SM09D1



Programming Cable (USB Port) PC37



Data Cable PC40



Keypad Microphone SM19A1



320W External Power Supply PS22002



Antenna



Caution: Use the accessories specified by Hytera only. If not, Hytera shall not be liable for any losses or damages arising out of use of unauthorized accessories.

Input Method

You can enter aliases, numbers or messages using the microphone with a keypad. The radio supports the following input methods: Chinese Pinyin (simplified), English and Number.

■ Chinese Pinyin (Simplified)

Operation:

1. Press **#,*** to switch to Chinese Pinyin mode;
2. Enter the pinyin through alphanumeric keys; then a list of possible combinations and corresponding characters will appear;
3. Use the **Up/Down** key to choose the right pinyin;
4. Press the **OK** key to highlight the characters, and choose the right character using the **Up/Down** key;
5. Press the **OK** key to enter the selected character.

You can repeat the above steps to continue.

■ English

Operation:

1. Press **#,*** to switch to uppercase English or lowercase English mode;
2. Enter the English letters through alphanumeric keys;
3. Use the **Up/Down** key to choose the right letter;
4. Press the **OK** key to enter the selected letter.

You can repeat the above steps to continue.

■ Number

Operation:

1. Press **#,*** to switch to Number mode;
2. Enter the numbers through alphanumeric keys **0** to **9** .

■ Special Character

To enter common punctuations and special characters, press **1** .

To input a space, press ***,*** .



Note: You can use the **Up/Down** key to move the cursor leftward/rightward in the entered text.